



SEA-BIRD
SCIENTIFIC

User Manual

Release Date: 02/18/2015

SBE Sea-Bird
Electronics

SBE 53 BPR

Bottom Pressure Recorder

Pressure and Temperature (conductivity optional) Recorder
with RS-232 Interface

Manual version
Firmware version
Software versions

- 013
- 2.1 & later
- Seasoft for Waves 2.0 & later



Sea-Bird Electronics
13431 NE 20th Street
Bellevue, Washington
98005 USA

Tel: +1 425-643-9866
seabird@seabird.com
www.seabird.com

Limited Liability Statement

Extreme care should be exercised when using or servicing this equipment. It should be used or serviced only by personnel with knowledge of and training in the use and maintenance of oceanographic electronic equipment.

SEA-BIRD ELECTRONICS, INC. disclaims all product liability risks arising from the use or servicing of this system. SEA-BIRD ELECTRONICS, INC. has no way of controlling the use of this equipment or of choosing the personnel to operate it, and therefore cannot take steps to comply with laws pertaining to product liability, including laws which impose a duty to warn the user of any dangers involved in operating this equipment. Therefore, acceptance of this system by the customer shall be conclusively deemed to include a covenant by the customer to defend, indemnify, and hold SEA-BIRD ELECTRONICS, INC. harmless from all product liability claims arising from the use or servicing of this system.

Declaration of Conformity

Sea-Bird Electronics, Inc.
13431 NE 20th Street, Bellevue, WA 98005 USA

DECLARATION OF CONFORMITY

Manufacturer's Name: Sea-Bird Electronics
Manufacturer's Address: 13431 NE 20th Street
Bellevue, WA 98005, USA

The Authorized Representative located within the Community is:
OTT MESSTECHNIK GmbH & Co.KG
P.O.Box: 2140 / 87411 Kempten / Germany
Ludwigstrasse 16 / 87437 Kempten
Internet: <http://www.ott.com>
Phone: +49 831 5617 – 100
Fax: +49 831 5617 - 209

Device Description: Various Data Acquisition Devices and Sensors

Model Numbers:

3S	3F	3plus	4C	4M	5T	5P	5M	7
8	9plus	11plus	14	16plus V2	16plus-IM V2		17plus V2	18
19plus V2	21	25plus	26plus	27	29	32	32C	32SC
33	35	35RT	36	37-IMP	37-IM	37-SMP	37-SM	37-SIP
37-SI	38	39	39-IM	39plus	41	41CP	43	43F
44	45	49	50	52-MP	53BPR	54	55	56
63	SIM	ICC	IMM	PDIM	AFM	90488	90204	90402
90504	Glider Payload CTD		NiMH Battery Charger and Battery Pack					

Applicable EU Directives: Machinery Directive 98 / 37 /EC
EMC Directive 2004 / 108 /EC
Low Voltage Directive (73 / 23 /EEC) as amended by (93 / 68 /EEC)

Applicable Harmonized Standards:
EN 61326-1:2006 Class A Electrical Equipment for Measurement, Control, and Laboratory Use, EMC Requirement – Part 1: General Requirements
(EN 55011:2007 Group 1, Class A)

EN 61010-1:2001, Safety Requirements for Electrical Equipments for Measurement, Control, and Laboratory Use – Part 1: General Requirements

Declaration based upon compliance to the Essential Requirements and Letter of Opinion from CKC Certification Services, LLC., Notified Body 0976

I, the undersigned, hereby declare that the equipment specified above conforms to the above European Union Directives and Standards.

Authorized Signature: 
Name: Nordeen Larson
Title of Signatory: President
Date: 3 September 2013
Place: Bellevue, WA

Table of Contents

Limited Liability Statement	2
Declaration of Conformity	3
Table of Contents	4
Section 1: Introduction	6
About this Manual	6
Quick Start	6
Unpacking SBE 53.....	7
Section 2: Description of SBE 53	8
System Description	8
Specifications.....	10
Dimensions and End Cap Connectors.....	12
Cables and Wiring	13
Power Supply.....	15
External Power and Cable Length	16
Limiting Communication IR Loss to 1 Volt if	
Transmitting Real-Time Data	16
Supplying Enough Power to SBE 53	16
Data I/O	17
Real-Time Setup	17
Baud Rate and Cable Length	17
Real-Time Data Acquisition	17
Section 3: Software Installation and Use	18
Software Installation	18
Seasoft for Waves Use.....	19
File Types	20
Section 4: Pre-Deployment Planning – Battery and Memory Endurance	21
Battery Endurance.....	22
Memory Endurance.....	23
Section 5: SBE 53 Setup, Installation, and Data Upload - SeatermW	24
Programming for Deployment - SeatermW	24
Command Descriptions.....	28
General Command Notes.....	28
Commands	29
Setting Time in SBE 53 to Synchronize Sampling of Multiple Instruments.....	42
Installing and Deploying SBE 53.....	43
Recovering SBE 53.....	44
Uploading Data from Memory.....	45
Section 6: Conversion into Tide and Reference Frequency Files – Convert Hex	47
Section 7: Tide Data Processing – Merge Barometric Pressure	49
Input Barometric Pressure File Format	51
Merge Barometric Pressure Algorithm	51
Section 8: Data Plotting – Plot Data	52
File Setup Tab.....	52
Plot Setup Tab.....	53
X Axis Tab.....	54
Y Axis Tab.....	55
Viewing and Outputting Plots.....	56

Section 9: Routine Maintenance and Calibration	58
Corrosion Precautions	58
Connector Mating and Maintenance	58
O-Ring Maintenance	59
Conductivity Cell Maintenance	59
Battery Replacement	60
Pressure Sensor Maintenance	61
Sensor Calibration	65
Section 10: Troubleshooting	68
Problem 1: Unable to Communicate with SBE 53	68
Problem 2: Nonsense or Unreasonable <i>Uploaded Data</i>	69
Problem 3: Nonsense or Unreasonable <i>Real-Time</i> or <i>Queried Data</i>	69
Glossary	70
Appendix I: Command Summary	71
Appendix II: Sample Timing	73
Notes	73
Sample Timing Schematics	74
Pressure Sensor and Reference Frequency Oscillator	
Continuously Powered	74
Pressure Sensor and Reference Frequency Oscillator	
<i>Not</i> Continuously Powered	77
Appendix III: Data Formats	80
Queried Data Format (.cap extension)	80
Real-Time Data Format (.cap extension)	80
Hex Data Format (.hex extension)	81
Tide Data Format (.tid extension)	84
Format with -t Command Line Option	84
Reference Frequency Data Format (.ref extension)	85
Making Corrections Using Reference Frequency Data	85
Appendix IV: Electronics Disassembly/Reassembly	86
Appendix V: AF24173 Anti-Foulant Device	88
Appendix VI: Pressure-to-Depth Conversion	92
Appendix VII: Replacement Parts	93
Appendix X: Manual Revision History	95
Index	97

Section 1: Introduction

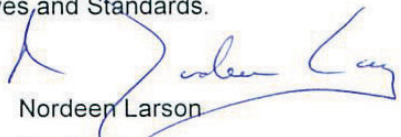
This section includes a Quick Start procedure, and photos of a typical SBE 53.

About this Manual

This manual is for use with the SBE 53 BPR Bottom Pressure Recorder. It is organized to guide the user from installation through operation, data collection, and processing. We have included detailed specifications, command descriptions, maintenance and calibration information, and helpful notes throughout the manual.

Sea-Bird welcomes suggestions for new features and enhancements of our products and/or documentation. Please contact us with any comments or suggestions (seabird@seabird.com or 425-643-9866). Our business hours are Monday through Friday, 0800 to 1700 Pacific Standard Time (1600 to 0100 Universal Time) in winter and 0800 to 1700 Pacific Daylight Time (1500 to 0000 Universal Time) the rest of the year.

Quick Start

Follow these steps to get a Quick Start using the SBE 53. The manual provides step-by-step details for performing each task.

Deployment:

1. Run Battery and Memory Endurance to determine sampling parameters (*Section 4*).
2. Install new batteries.
3. Connect SBE 53 to computer and run SeatermW (*Section 5*):
 - A. Ensure all data has been uploaded, and then send **InitLogging** to make entire memory available for recording if desired.
 - B. Set date and time (**SetTime**) and tide sampling parameters (**SetSampling**); enable conductivity if SBE 4M conductivity sensor is installed (**Conductivity=Y**).
 - C. Check status (**DS**) and calibration coefficients (**DC**).
 - D. Start logging (**Start**).

Recovery and Data Processing:

1. Connect SBE 53 to computer and run SeatermW. Stop logging (**Stop**), and upload data from SBE 53 memory (*Section 5*).
2. Run Convert Hex to convert uploaded data into tide and reference frequency files (*Section 6*).
3. Run Merge Barometric Pressure to remove barometric pressure from tide file (*Section 7*).
4. Run Plot Data to display the data (*Section 8*).

Unpacking SBE 53

Shown below is a typical SBE 53 shipment.



SBE 53



I/O cable



Pressure sensor oil refill kit



Spare battery end cap hardware and o-ring kit



Spare hardware kit



Jackscrew kit



Software, and electronic copy of user manual

Section 2: Description of SBE 53

This section describes the functions and features of the SBE 53, including specifications, dimensions, end cap connectors, power supply information, cable length limitations, data I/O protocols, and real-time setup.

System Description

The SBE 53 BPR measures full ocean depth water level with extremely high resolution, accuracy, and stability. The SBE 53 combines a uniquely precise and stable time base with low power frequency acquisition circuitry, Paroscientific Digiquartz[®] pressure transducer, non-volatile 32 MB FLASH memory, and a precision thermometer, to provide unprecedented bottom pressure recording capability. An optional conductivity sensor (SBE 4M) can be added to provide salinity data as well.

The SBE 53 integrates pressure measurements to obtain water levels (tides) unaffected by wave action. The interval between each water level measurement and the duration of the integration period are user-programmable. The interval is programmable over a range of 1 minute to 1 hour. The integration duration is programmable from 1 minute to the entire user-defined tide interval. The SBE 53 can continuously power the pressure transducer and reference frequency oscillator, eliminating turn-on transients and providing the highest quality data. Alternatively, the SBE 53 can be programmed to enter a power-down state between measurements to conserve battery power for very long deployments, with a user-specified *warm-up* period before each pressure measurement. Temperature data is recorded with each pressure integration. An SBE 4M conductivity sensor can be integrated for recording conductivity data with each tide measurement. Logging (recording) can be programmed to start and stop at specified times after the instrument is deployed. Data is always recorded in memory; in addition, real-time data can be output.

Large memory and low power requirements permit frequent water level recording. For example, with alkaline D-cell batteries, a 420-day deployment could include water level measurements every 30 minutes (integrating pressure for the entire 30 minutes); a 2-year deployment could be achieved if pressure integration is limited to 4 minutes for each water level measurement, with a 15-minute warm-up of the pressure sensor and reference frequency oscillator before each measurement. Alternatively, deployments approximately 3 times longer are possible with Electrochem DD lithium batteries. Binary upload of data in memory can be accomplished at up to 115,200 baud.

The SBE 53 is self-contained in a rugged, non-corroding, titanium housing for depths to 7000 meters. After recovery (and without opening the housing), the recorded data is transferred to a computer via an RS-232C data link for analysis, plotting, and permanent archiving. The battery compartment contains twelve alkaline D-cells (Duracell MN1300, LR20) and is sealed separately to minimize risk to the electronics.

The pressure sensor, a Paroscientific Digiquartz pressure sensor with a temperature-compensated quartz element, is available in 1300, 2000, 4000, and 6800 meter ranges (2000, 3000, 6000, and 10000 psia).

The pressure and internal temperature compensation (pressure temperature) signals (frequencies) from the transducer are integrated in parallel for the tide integration duration. The measurement times are set by a continuously powered, real-time clock with an accuracy of ± 5 seconds/month. Long-term drift of the counter's reference frequency is on the order of 1 ppm per year. To allow for correction of drift, an ovenized crystal oscillator is programmed to make a reference frequency measurement periodically.

Temperature is measured with an aged, super-stable thermistor embedded in the SBE 53 end cap. An AC excitation is applied to a hermetically sealed VISHAY reference resistor and the thermistor. A 24-bit A/D converter digitizes the reference resistor and thermistor outputs.

The SBE 53 includes:

- Titanium housing for depths to 7000 meters (22,900 ft)
- 1300, 2000, 4000, or 6800 meter (2000, 3000, 6000, or 10000 psia) Paroscientific Digiquartz temperature-compensated pressure sensor
- Temperature sensor –
Internal thermistor embedded in end cap (0.01 °C accuracy, 0.001 °C resolution) **OR**
High-accuracy external temperature sensor (0.002 °C accuracy, 0.0001 °C resolution)
- Frequency input channel and bulkhead connector for optional SBE 4M conductivity sensor
- 32 MB FLASH memory
- 12 alkaline D-cell batteries (Duracell MN1300, LR20); battery compartment is separated from electronics by a moisture-proof seal
- Impulse glass-reinforced epoxy XSG or Wet-pluggable (MCBH) bulkhead connectors

SBE 53 options include:

- SBE 4M conductivity sensor, interfaced via bulkhead connector and clamped to SBE 53 housing. SBE 4M comes equipped with expendable AF24173 Anti-Foulant Devices.
- Lithium batteries (six DD drop-in batteries with buttons) for longer deployments (lithium batteries **not** supplied by Sea-Bird). Note that one lithium DD battery is shorter than two alkaline D batteries, so a different battery cover plate is required if using the lithiums (cover plate available from Sea-Bird).

Future upgrades and enhancements to the SBE 53 firmware can be easily installed in the field through a computer serial port and the data I/O bulkhead connector on the SBE 53, without the need to return the SBE 53 to Sea-Bird.

Notes:

- Help files provide detailed information on Seasoft for Waves.
- **Seasoft for Waves data processing modules cannot process real-time data from the SBE 53.**
- Sea-Bird supplies the current version of our software when you purchase an instrument. As software revisions occur, we post the revised software on our website. See our website for the latest software version number, a description of the software changes, and instructions for downloading the software.

The SBE 53 is supplied with a modular Windows package, Seasoft for Waves. The software provides pre-deployment planning, communication with the SBE 53 for setup and uploading of data, conversion of the uploaded data, removal of barometric pressure from tide data, and data plotting.

Specifications

Note:

The pressure sensor is mounted on the titanium connector end cap, with the pressure conveyed from the pressure port to the sensor via an oil-filled tube. The pressure reading is position sensitive as a result of the oil pressure head.

Pressure	
Range	0 to 1300, 2000, 4000, or 6800 m (2000, 3000, 6000, or 10,000 psia)
Accuracy *	± 0.01% of full scale
Repeatability	0.005% of full scale
Hysteresis	0.005% of full scale
Calibration	0 psia to full scale pressure
Resolution	0.045 ppm (0.3 mm for 10,000 psia range, 1-minute integration, continuously powered)
Temperature with Internal Thermistor	
Range	-5 to +35 °C
Accuracy	± 0.01 °C
Resolution	0.001 °C
Calibration	+1 to +32 °C (measurements outside this range may be at slightly reduced accuracy due to extrapolation errors)
High Accuracy Temperature with External Thermistor	
Range	-5 to +35 °C
Accuracy	± 0.002 °C
Resolution	0.0001 °C
Calibration	+1 to +32 °C (measurements outside this range may be at slightly reduced accuracy due to extrapolation errors)
Conductivity (optional SBE 4M conductivity sensor)	
Range	0.0 to 7 S/m
Accuracy	±0.0003 S/m/month (typical); ±0.001 S/m/month (guaranteed; not applicable in areas of high bio-fouling or contamination or if Application Note 2D procedures are not followed)
Resolution	0.00002 S/m
Calibration	2.6 to 6 S/m plus zero conductivity (air)
Clocks	
Clocks	<p>Counter Time Base (for pressure and pressure temperature): Quartz TCXO ± 3 ppm per year aging (± 1 ppm per year typical), ± 0.1 ppm (0 - 20 °C)</p> <p>Ovenized Crystal Oscillator (for reference frequency drift correction): Warm-up re-stabilization: less than ± 1 x 10⁻⁷ Stability vs. temperature: ± 0.1 ppm (-20 °C to +70 °C) Aging: less than 1 x 10⁻⁷ per year, less than 1 x 10⁻⁶ /10 years</p> <p>Real-Time Clock (for time stamp and sample timing): Quartz TCXO watch-crystal type 32,768 Hz; accuracy ± 2 ppm (5 seconds/month). Battery-backed for minimum of 2-year operation, without main batteries installed.</p> <p>Conductivity Time Base: Quartz TCXO ± 1 ppm per year aging; ± 15 ppm (-20 to +70 °C)</p>

* Digiquartz residual temperature sensitivity is measured at Sea-Bird, and the Digiquartz calibration coefficients are adjusted so that the residual temperature sensitivity is less than 1 ppm over the range of 0 – 20 °C (0.05 ppm/°C; 0.0005 psia for a 10,000 psia range sensor).

Note:
See Section 4: Pre-Deployment Planning – Plan Deployment and Battery and Memory Endurance.

Other Specifications	
Memory	32 MB Flash RAM
Data Storage	If conductivity not enabled: Bytes/day = 17 (T + R) If conductivity enabled: Bytes/day = 20 (T + R) (T = tide samples/day, R = reference frequency samples/day)
Power Requirement	<p>Quiescent (sleep, when not logging): 0.0005 watt</p> <p>Communications: 0.10 watt</p> <p>Data Upload: 0.17 watt</p> <p>Logging:</p> <p style="padding-left: 20px;">Digiquartz & Reference Frequency Oscillator</p> <p style="padding-left: 20px;"><i>Case 1: Continuously powered, tide duration = tide interval</i></p> <p style="padding-left: 20px;">Powered and Integrating 0.016 watt</p> <p style="padding-left: 20px;">*General (per measurement) 0.31 watt-seconds = 0.31 joules</p> <p style="padding-left: 20px;"><i>Case 2: Continuously powered, tide duration < tide interval</i></p> <p style="padding-left: 20px;">Powered and Integrating 0.016 watt</p> <p style="padding-left: 20px;">Powered but not Integrating 0.012 watt</p> <p style="padding-left: 20px;">*General (per measurement) 0.47 watt-seconds = 0.47 joules</p> <p style="padding-left: 20px;"><i>Case 3: Not continuously powered, tide duration < tide interval</i></p> <p style="padding-left: 20px;">Powered and Integrating 0.016 watt</p> <p style="padding-left: 20px;">Powered but not Integrating 0.012 watt</p> <p style="padding-left: 20px;">Powered down 0.0005 watt</p> <p style="padding-left: 20px;">*General (per measurement) 0.66 watt-seconds = 0.66 joules</p> <p style="padding-left: 20px;">Optional Conductivity 0.23 watt-seconds = 0.23 joules</p> <p style="padding-left: 20px;">Reference Frequency</p> <p style="padding-left: 20px;">Total per measurement 250 watt-seconds = 250 joules</p> <p style="padding-left: 20px;">Peak 1.5 watts</p> <p style="padding-left: 20px;">*General (per measurement) includes taking temperature measurement as well as storing data, etc.</p>
Power Supply	<p>12 alkaline D-cell batteries (Duracell MN1300, LR20): Typical capacity 756,000 joules. Sea-Bird recommends derating 15% for safety, and 5% per year for battery self-discharge. Consider derating further for cold water applications.</p> <p>Other: 6 lithium DD-cell batteries (Electrochem BCX85-3B76-TC) with buttons (lithiums not supplied by Sea-Bird). Note that 1 lithium DD is shorter than 2 alkaline Ds, so different battery cover plate required (cover plate available from Sea-Bird). Typical capacity 2,332,800 joules. Sea-Bird recommends derating 15% for safety, and 3% per year for battery self-discharge.</p> <p>External power source: 12 - 24 VDC.</p>
Housing Materials	7000-meter titanium housing and end cap
Weight (with alkaline batteries)	14.5 kg (32 lbs) in air, 8.6 kg (19 lbs) in water

Dimensions and End Cap Connectors

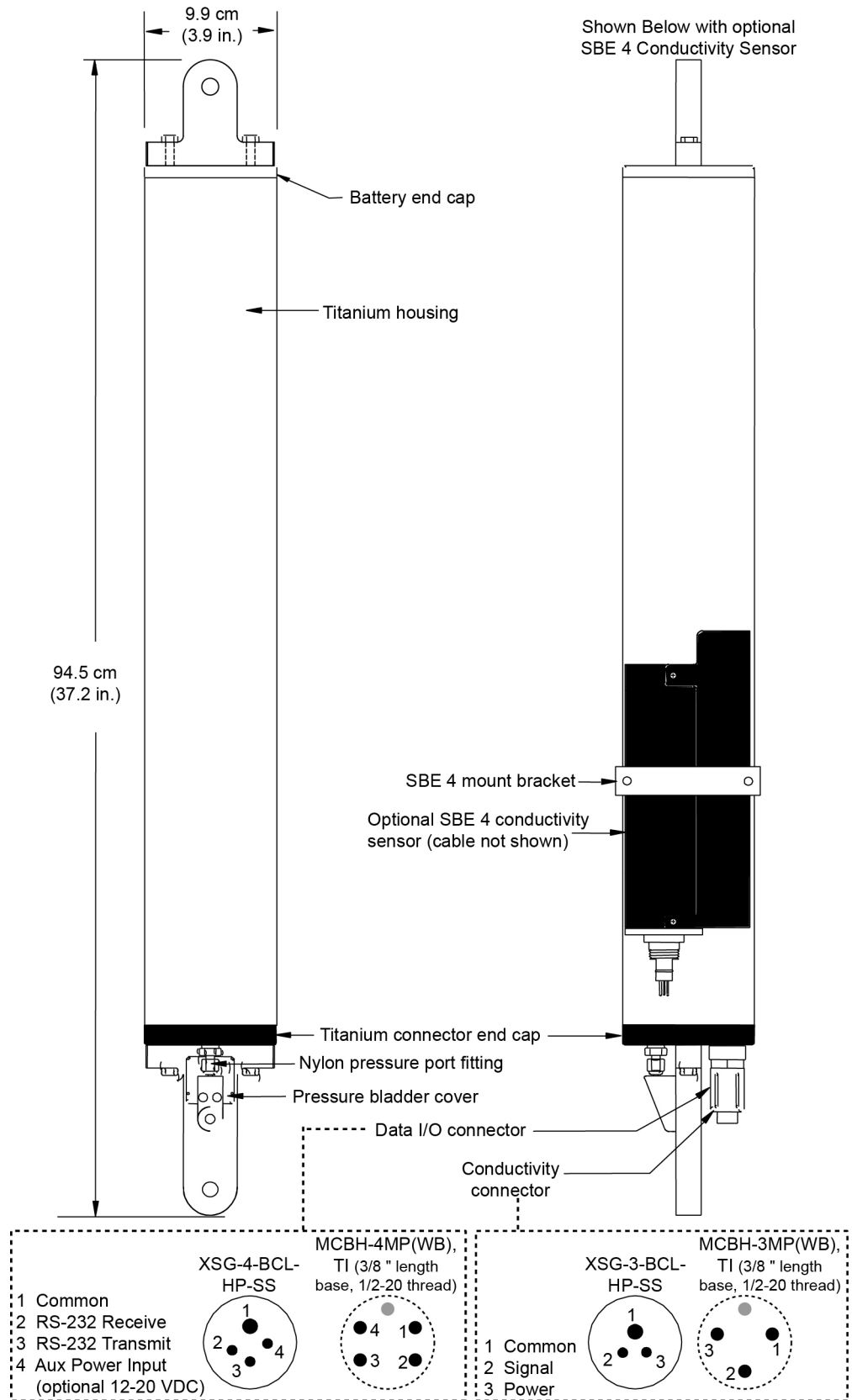

Cables and Wiring

Data I/O cable

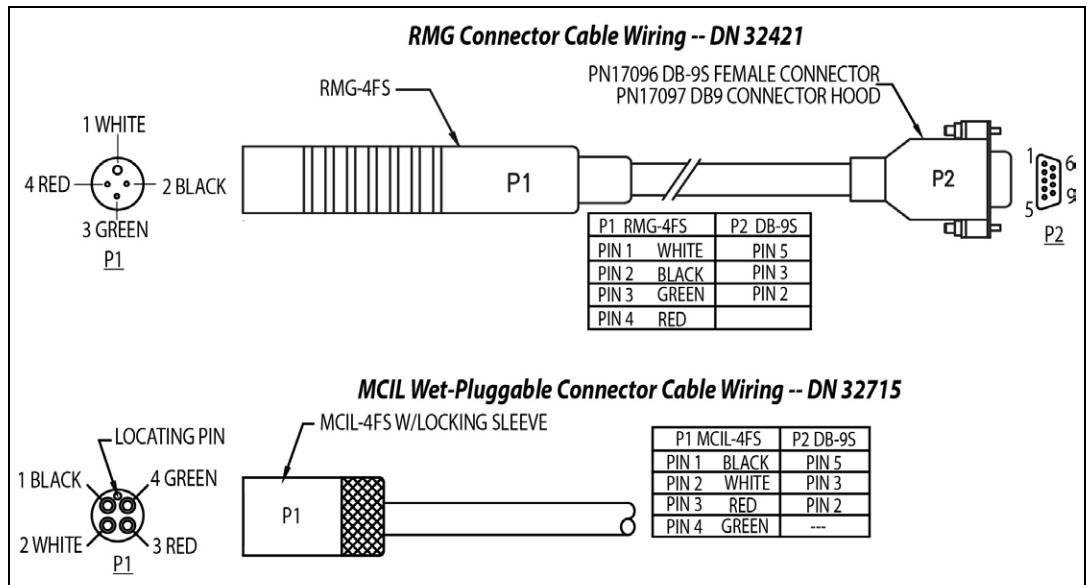

Conductivity sensor cable - for optional SBE 4 conductivity sensor

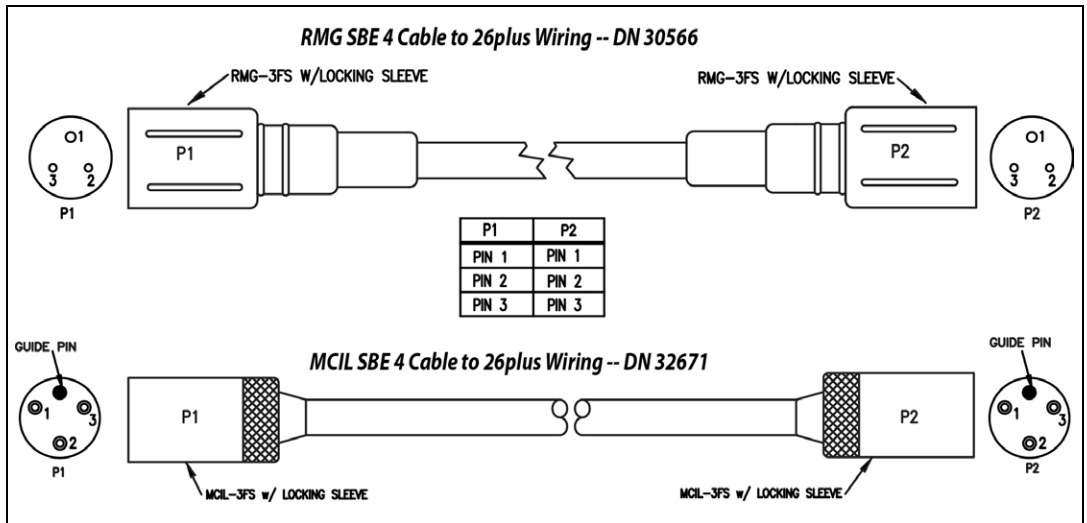

Internal Wiring – with XSG connectors

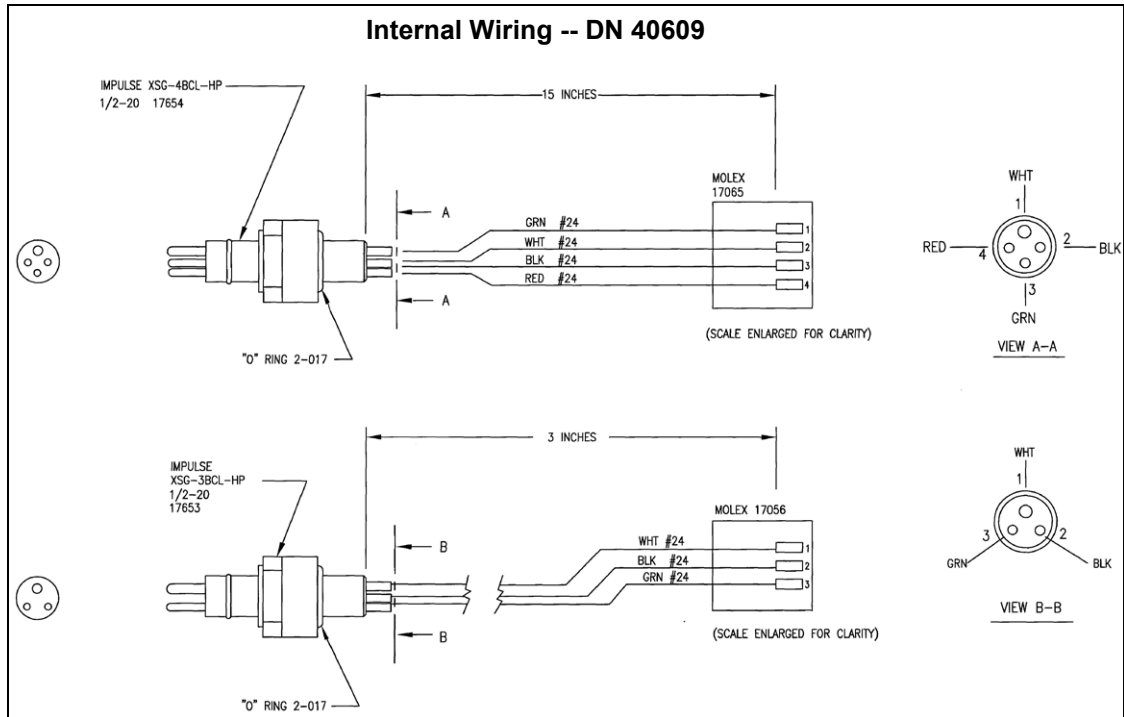

Internal Wiring – with MCBH connectors

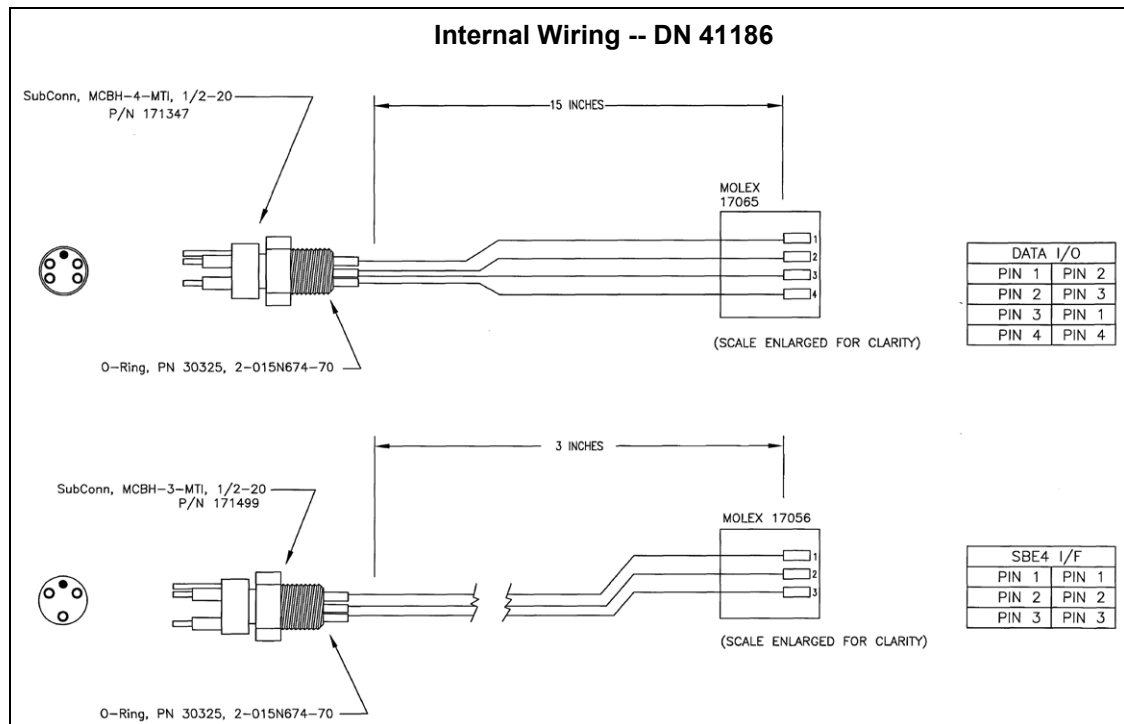

Power Supply

Notes:

- For battery endurance calculations, see *Section 4: Pre-Deployment Planning – Battery and Memory Endurance*.
- The cut-off voltage is 9.25 volts. If the voltage falls below that, the SBE 53 provides a warning message, and will not take measurements.

The main batteries are 12 D-cell alkaline batteries (Duracell MN 1300, LR20). The SBE 53 can also be powered by 6 DD-cell batteries with buttons (batteries **not** supplied by Sea-Bird).

The SBE 53 can be powered from an external 12-24 VDC source. The internal batteries are diode-OR'd with the external source, so power is drawn from whichever voltage source is higher.

On-board lithium batteries (non-hazardous units which are unrestricted for shipping purposes) are provided to back-up the buffer and the real-time clock in the event of main battery failure, exhaustion, or removal. The main batteries can be replaced without affecting either the real-time clock or the memory. If the main power supply falls below 9 VDC, the SBE 53 will draw power from the back-up lithium batteries.

External Power and Cable Length

Note:

See *Real-Time Setup* below for baud rate limitations on cable length if transmitting real-time data.

There are two issues to consider if powering the SBE 53 externally:

- Limiting the communication IR loss to 1 volt **if transmitting real-time data**; higher IR loss will cause the instrument to transmit data that does not meet the RS-232 communication standard.
- Supplying enough power at the power source so that sufficient power is available at the instrument after considering IR loss.

Each issue is discussed below.

Note:

Common wire resistances:

Gauge	Resistance (ohms/foot)
12	0.0016
14	0.0025
16	0.0040
18	0.0064
19	0.0081
20	0.0107
22	0.0162
24	0.0257
26	0.0410
28	0.0653

Limiting Communication IR Loss to 1 Volt if Transmitting Real-Time Data

The limit to cable length is typically reached when the maximum current during *communication* times the power common wire resistance is more than 1 volt.

$$V_{\text{limit}} = 1 \text{ volt} = IR_{\text{limit}}$$

$$\text{Maximum cable length} = R_{\text{limit}} / \text{wire resistance per foot}$$

where I = maximum current required by SBE 53 during communication.

From *Specifications*, upload power required is 0.17 watt. Use 12 V (minimum input voltage) to calculate:

$$I * V = \text{watts}$$

$$I = 0.17 \text{ watts} / 12\text{V} = 0.0142 \text{ amps}$$

Example 1 – For 20 gauge wire, what is maximum distance to transmit power if transmitting real-time data?

For upload current, $R_{\text{limit}} = V_{\text{limit}} / I = 1 \text{ volt} / 0.0142 \text{ amps} = 70.4 \text{ ohms}$.

For 20 gauge wire, resistance is 0.0107 ohms/foot.

Maximum cable length = $70.4 \text{ ohms} / 0.0107 \text{ ohms/foot} = 6582 \text{ feet} = 2006 \text{ m}$

Example 2 – Same as above, but there are 4 instruments powered from the same power supply.

For upload current, $R_{\text{limit}} = V_{\text{limit}} / I = 1 \text{ volt} / (0.0142 \text{ amps} * 4 \text{ instruments}) = 17.6 \text{ ohms}$

Maximum cable length = $17.6 \text{ ohms} / 0.0107 \text{ ohms/foot} = 1645 \text{ feet} = 502 \text{ m}$ (to SBE 53 *furthest* from power source).

Supplying Enough Power to SBE 53

Another consideration in determining maximum cable length is supplying enough power at the power source so that sufficient voltage is available, after IR loss in the cable, to power the SBE 53 externally.

The maximum power draw is for the reference frequency measurement, 1.5 watts. Use 12 V (minimum input voltage) to calculate:

$$I * V = \text{watts}$$

$$I = 1.5 \text{ watts} / 12\text{V} = 0.125 \text{ amps}$$

Example 1 – For 20 gauge wire, what is maximum distance to transmit power to SBE 53 from a 12 VDC power supply?

SBE 53 external power specification is 12 – 24 VDC. Battery cut-off (point at which SBE 53 stops taking measurements) is 9.25 V.

Therefore, a 2.75 V IR drop (12 V – 9.25 V) would still provide enough power to SBE 53.

$$V = IR \quad 2.75\text{V} = 0.125 \text{ amps} * (0.0107 \text{ ohms/foot} * \text{cable length})$$

Maximum cable length = 2056 ft = 626 m

Note that 626 meters < 2142 m (maximum distance if SBE 53 is transmitting real-time data), so IR drop in power is controlling factor for this example. Using a higher voltage power supply or a different wire gauge would increase allowable cable length.

Example 2 – Same as above, but there are 4 instruments powered from same power supply.

$$2.75\text{V} = 0.125 \text{ amps} * 4 \text{ instruments} * (0.0107 \text{ ohms/foot} * \text{cable length})$$

Maximum cable length = 514 ft = 156 m (to SBE 53 *furthest* from power source)

Data I/O

The SBE 53 receives setup instructions and outputs diagnostic information or previously recorded data via a three-wire RS-232 link. The SBE 53 is factory-configured for 9600 baud, 8 data bits, 1 stop bit, and no parity. The communications baud rate can be changed using **Baud=** (see *Section 5: SBE 53 Setup, Installation, and Data Upload – SeatermW*). ASCII data upload from memory is done at the communications baud rate. Binary data upload from memory can be accomplished at rates of up to 115,200 baud, regardless of the setting for the communications baud rate.

Real-Time Setup

Notes:

- Set:
 - Baud rate with **Baud=**.
 - **TxTide=Y** for real-time tide data.
 See *Section 5: SBE 53 Setup, Installation, and Data Upload – SeatermW* for command details.
- If using external power, see *External Power and Cable Length* above for power limitations on cable length.

Baud Rate and Cable Length

The length of cable that the SBE 53 can drive is dependent on the baud rate. The allowable combinations are:

Maximum Cable Length (meters)	Maximum Baud Rate
1600	600
800	1200
400	2400
200	4800
100	9600
50	19200
25	38400
16.7	57600 *
13.3	115200 *

* 57600 and 115200 baud are available only for binary upload, and are not applicable to real-time data output.

Real-Time Data Acquisition

Real-time tide data can be saved by clicking Capture in SeatermW before you begin logging. The data displayed in SeatermW will be saved to the designated file. Process the data as desired. Note that this file **cannot be processed by Seasoft for Waves, as it does not have the required headers and format for Sea-Bird's processing software.**

Section 3: Software Installation and Use

Notes:

- Help files provide detailed information on Seasoft for Waves.
- **Seasoftware for Waves data processing modules cannot process real-time data from the SBE 53.**
- Sea-Bird supplies the current version of our software when you purchase an instrument. As software revisions occur, we post the revised software on our website. See our website for the latest software version number, a description of the software changes, and instructions for downloading the software.

This section describes the installation and use of Seasoft for Waves.

The SBE 53 is supplied with a modular Windows software package, **Seasoftware for Waves**. The software provides pre-deployment planning, communication with the SBE 53 for setup and uploading of data from the SBE 53, conversion of the uploaded data, removal of barometric pressure from tide data, and data plotting.

Software Installation

Although Seasoft for Waves was designed to work with a PC running Win 2000/XP, extensive testing has not shown any compatibility problems when using the software with a PC running Vista or Windows 7 (32-bit or 64-bit).

If not already installed, install Seasoft for Waves on your computer using the supplied software CD-ROM:

1. Insert the CD in your CD drive.
2. Install the software: Double click on **SeasoftwareWaves_V*_**_.exe** (*_** is the software version). Follow the dialog box directions to install the software.

The default location for the software is
c:\Program Files\Sea-Bird\SeasoftwareWaves.

Seasoft for Waves Use

Start Seasoft for Waves by double clicking on SeasoftWavesLaunch.exe. The main screen looks like this:

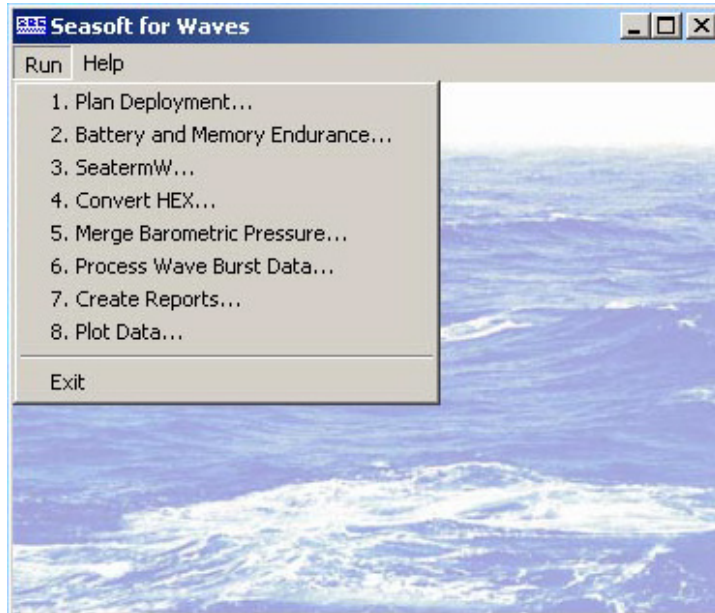

The Run menu lists each program module:

Type	Module Name	Module Description
Pre-deployment planning See Section 4	Plan Deployment	Not applicable to SBE 53.
	Battery and Memory Endurance	Calculate nominal battery and memory endurance for user-specified sampling scheme.
Terminal program See Section 5	SeatermW	Send commands for status, data acquisition setup, diagnostics, and data upload.
Data conversion See Section 6	Convert Hex	Convert uploaded .hex data file into .tid tide file (with output data in engineering units) and .ref reference frequency file.
Tide data processing See Section 7	Merge Barometric Pressure	Remove barometric pressure from tide data in .tid file, output a .tid file.
Wave data processing	Process Wave Burst Data	Not applicable to SBE 53.
	Create Reports	Not applicable to SBE 53.
Data plotting See Section 8	Plot Data	Plot data from a .tid file; plots can be printed.

File Types

File extensions are used by Seasoft for Waves to indicate the file type:

Extension	Description
.bmp	Bitmap graphics file created by Plot Data.
.bp	Barometric pressure data, used by Merge Barometric Pressure to remove barometric pressure from the tide data (.tid) file. This file, not supplied by Sea-Bird, is created by user, based on local barometric pressure data (such as that from a local weather station). See <i>Section 7: Tide Data Processing – Merge Barometric Pressure</i> .
.cap	Real-time data, queried data, and/or diagnostics captured using SeatermW.
.hex	Data uploaded from SBE 53 memory using SeatermW.
.ini	<p>There are two .ini files used in Seasoft for Waves:</p> <ul style="list-style-type: none"> SeasoftWaves.ini contains the location and file name of the last saved Program Setup (.psa) file and options settings for each module with a .psa file (Convert Hex, Merge Barometric Pressure, and Plot Data). SeatermW.ini contains the last instrument type (SBE 26 or 26plus), COM port, and baud rate used in SeatermW for communicating with the instrument. <p>Note: SBE 26plus communications settings are compatible with the SBE 53.</p> <p>The .ini files are saved to %USERPROFILE%\Local Settings\Apps\Sea-Bird (Example C:\Documents and Settings\dbresko\ Local Settings\Apps\Sea-Bird)</p>
.jpg	JPEG graphics file created by Plot Data.
.psa	<p>Program Setup file, used by Convert Hex, Merge Barometric Pressure, and Plot Data to store setup information (such as input and output file names and locations, and processing instructions). The user can save the .psa files to the desired locations. As a default, the .psa files are saved to %USERPROFILE%\Application Data\SeasoftWaves (Example C:\Documents and Settings\dbresko\ Application Data\Sea-Bird\SeasoftWaves).</p>
.ref	Reference frequency file, created from uploaded .hex file by Convert Hex.
.tid	Tide measurements in engineering units, created from uploaded .hex file by Convert Hex. Also, file format for tide data that has had barometric pressure removed by Merge Barometric Pressure.
.wmf	Windows metafile graphics file created by Plot Data.

See *Appendix III: Data Formats* for details on the format of each file.

Section 4: Pre-Deployment Planning – Battery and Memory Endurance

Note:

See *Specifications in Section 2: Description of SBE 53* for power and memory specifications.

This section covers calculating battery and memory endurance for the desired sampling scheme, using the Battery and Memory Endurance module in Seasoft for Waves. Power and memory endurance calculations for the SBE 53 are complex, and are dependent on the sampling scheme. Use Battery and Memory Endurance to calculate the endurance for a user-specified sampling scheme.

In Seasoft for Waves’ Run menu, select Battery and Memory Endurance. Click on the SBE 53 tab in the dialog box. The dialog box looks like this:

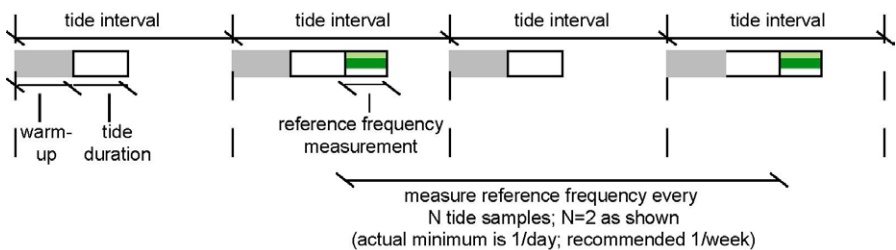

Notes:

- Drawing is schematic only, intended to define the sampling scheme terminology. See *Appendix II: Sample Timing* for timing details.
- See *Command Descriptions in Section 5: SBE 53 Setup, Installation, and Data Upload – SeatermW* for programming desired sampling scheme in SBE 53.
- Powering pressure continuously provides highest quality data. If not powering continuously, minimum warm-up is 5 minutes; Sea-Bird recommends 15 minutes or more.

Notes:

- See *Specifications* in *Section 2: Description of SBE 53* for power requirements and alkaline and lithium battery ratings.
- 1 watt-second = 1 joule

Discussions follow of the data and equations used in Battery and Memory Endurance; use this information to perform your own calculations if desired.

Battery Endurance

Examples: SBE 53 with alkaline D-cell batteries, no conductivity sensor. Measure tides at 30 minute intervals (48 measurements/day). Take 1 reference frequency measurement per week (1 after every 336 tide measurements [= 48 * 7]).

Reference frequency measurement (calculating pro-rated power per day for measurement once per week)
 $= 250 \text{ watt-sec/week} * 1 \text{ week} / 7 \text{ days} = \mathbf{36 \text{ joules/day}}$

Alkaline battery capacity and derating:

Alkaline battery capacity = 756,000 joules * 0.85 (derate for safety) = 642,600 joules

Derating 5% per year for battery self-discharge: $0.05 * 642,600 \text{ joules} / 365 \text{ days per year} = \mathbf{88 \text{ joules/day}}$

(Note: If conductivity sensor included, add $0.23 \text{ joules/measurement} * 48/\text{day} = \mathbf{11 \text{ joules/day}}$ to power requirement.)

Example 1 (Case 1 in Specifications): 30-minute (1800 sec) duration; power pressure sensor and reference frequency oscillator continuously while sampling. (Note: this is same sampling scheme as shown in Battery and Memory Endurance dialog box above.)

Digiquartz & reference frequency oscillator power =
 $[(0.016 \text{ watt} * 1800 \text{ sec}) + 0.31 \text{ watt-sec}] * 48/\text{day} = \mathbf{1397 \text{ joules/day}}$

Adding reference frequency and battery derating: **Total power/day** = 1397 + 36 + 88 = **1521 joules/day**

Battery endurance = 642,600 joules / 1521 joules/day = **422 days = 1.2 years**

Example 2 (Case 2 in Specifications): 3-minute (180 sec) duration; power pressure sensor and reference frequency oscillator continuously while sampling.

Digiquartz & reference frequency oscillator power =
 $[(0.016 \text{ watt} * 180 \text{ sec}) + (0.012 \text{ watt} * 1620 \text{ sec}) + 0.47 \text{ watt-sec}] * 48/\text{day} = \mathbf{1094 \text{ joules/day}}$

Adding reference frequency and battery derating: **Total power/day** = 1094 + 36 + 88 = **1218 joules/day**

Battery endurance = 642,600 joules / 1218 joules/day = **528 days = 1.4 years**

Example 3 (Case 3 in Specifications): 3-minute (180 sec) duration; power down pressure sensor and reference frequency oscillator after each measurement; provide a 15-minute (900 sec) warm-up for each measurement.

Digiquartz & reference frequency oscillator power =
 $[(0.016 \text{ watt} * 180 \text{ sec}) + (0.012 \text{ watt} * 900 \text{ sec}) + (0.0005 \text{ watt} * 720 \text{ sec}) + 0.66 \text{ watt-sec}] * 48/\text{day} = \mathbf{706 \text{ joules/day}}$

Adding reference frequency and battery derating: **Total power/day** = 706 + 36 + 88 = **830 joules/day**

Battery endurance = 642,600 joules / 830 joules/day = **774 days = 2.1 years**

However, Sea-Bird recommends that alkaline batteries should not be expected to last longer than 2 years in the field. Battery and Memory Endurance provides a warning that deployments longer than 2 years are not recommended with alkaline batteries.

As a check, compare each of these examples with the output of Battery and Memory Endurance; the program shows the same results.

Memory Endurance

Note:

The current version of the SBE 53 ignores the storing of the reference frequency measurements when calculating memory endurance for the status (**DS**) command output. This has a very small effect on memory endurance, and will be corrected in the next firmware revision.

The SBE 53 comes with a 32 MB memory. Memory used for storing logged data is:

If conductivity not enabled: Bytes/day = 17 (T + R)

If conductivity enabled: Bytes/day = 20 (T + R)

where

T = number of tide samples/day

R = number of reference frequency measurements/day

Examples: SBE 53 with conductivity sensor.

Example 1 - Measure tides every 30 minutes (2/hour * 24 hours = 48 measurements/day).

Measure reference frequency every 336 tide intervals (1 measurement/week).

T = 48, R = 1/7 = 0.14286

Bytes/day = 20 (T + R) = 20 (48 + 0.14286) = 962.9 bytes/day

Memory capacity ≈ 32 MB * 1024 * 1024 = 33,554,432 bytes

Memory endurance ≈ 33,554,432 / 962.9 = 34847 days = 95 years !!!

Example 2 - Measure tides every 1 minute (maximum sampling rate) (60/hour * 24 hours = 1440 measurements/day). Reference frequency measurement is disabled because tide duration < 10 minutes.

T = 1440, R = 0

Bytes/day = 20 (T + R) = 20 (1440 + 0) = 28800 bytes/day

Memory capacity ≈ 32 MB * 1024 * 1024 = 33,554,432 bytes

Memory endurance ≈ 33,554,432 / 28800 = 1165 days = 3.2 years

As a check, compare with the output of Battery and Memory Endurance; the program shows the same results. As you can see from these examples, memory capacity is not a limiting factor in deployment length.

Section 5: SBE 53 Setup, Installation, and Data Upload - SeatermW

This section covers:

- Programming the SBE 53 for deployment using SeatermW
- Command descriptions
- Installing and deploying the SBE 53
- Uploading data from the SBE 53 memory using SeatermW

Programming for Deployment - SeatermW

1. Connect the SBE 53 to the computer using the 4-pin data I/O cable:
 - A. By hand, unscrew the locking sleeve from the SBE 53 I/O (4-pin) connector. If you must use a wrench or pliers, be careful not to loosen the I/O connector instead of the locking sleeve.
 - B. Remove the dummy plug from the SBE 53 I/O connector by pulling the plug firmly away from the connector.
 - C. **XSG Connector** - Install the Sea-Bird I/O cable connector, aligning the raised bump on the side of the connector with the large pin (pin 1 - ground) on the SBE 53. **OR**
MCBH Connector – Install the cable, aligning the pins.
 - D. Connect the I/O cable connector to your computer's serial port.
2. In Seasoft for Waves Run menu, select SeatermW.
The main screen looks like this:

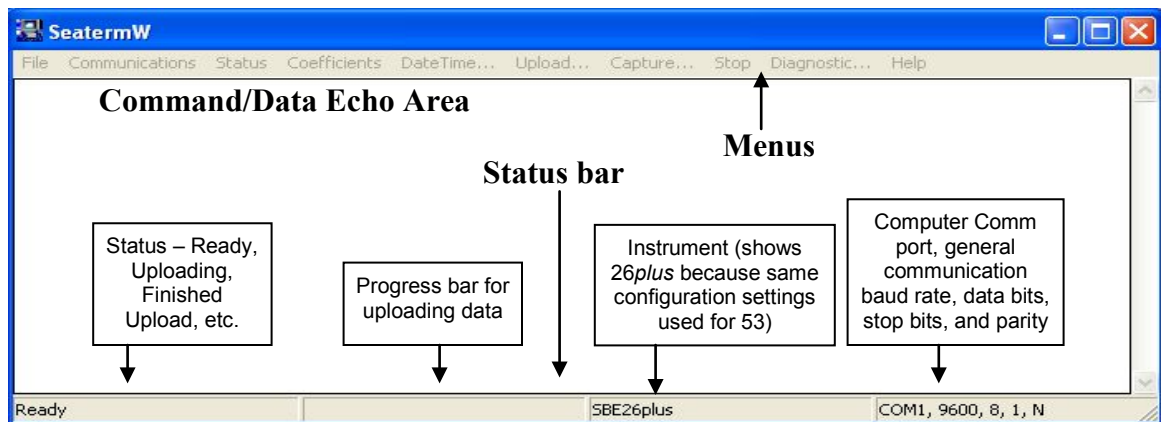

Note:

Once the system is configured and connected (Steps 3 and 4 below), to update the Status bar, click Status. SeatermW sends the status command (**DS**), which displays in the Command/Data Echo Area, and updates the Status bar.

- Menu – Contains tasks and frequently executed instrument commands.
- Command/Data Echo Area – Echoes a command executed using a Menu, as well as the SBE 53 response. Additionally, a command can be manually typed in this area, from the available commands for the SBE 53. The SBE 53 must be *awake* for it to respond to a command (use Connect to wake up the SBE 53).
- Status bar – Provides status information.

Following is a description of the menus:

Note:
You must be *connected* to the instrument (Connect) when using Status, Coefficients, Upload, Stop, or Diagnostic.

Menu	Description	Equivalent Command*
File	Exit SeatermW.	-
Communications	Connect / Disconnect - Re-establish communications with SBE 53. Computer responds with S> prompt. SBE 53 goes to sleep after 2 minutes without communication from computer have elapsed. Configure - Establish communication parameters (instrument, Comm port, and baud rate).	(press Enter key)
Status	Display SBE 53 setup and status (logging, samples in memory, etc.).	DS
Coefficients	Display pressure, temperature, and optional conductivity sensor calibration coefficients.	DC
DateTime	Set SBE 53 date and time based on time in computer. See <i>Setting Time in SBE 53 to Synchronize Sampling of Multiple Instruments</i> for details.	DateTime=x
Upload	Upload data stored in memory, in format our data processing module (Convert Hex) can use. Uploaded data has .hex extension. Before using, verify SBE 53 has stopped logging (send Stop unless you had input and enabled a pre-programmed stop time before beginning logging).	Upload with DD or DBbaud,b,e (use Upload if you will be processing data with Seasoft for Waves' Convert Hex module)
Capture	Capture SBE 53 responses on screen to file; to save real-time data or may be useful for diagnostics. File has .cap extension. Click Capture again to turn off capture. Capture status displays in Status bar.	-
Stop	Interrupt and end current activity, such as uploading data or running diagnostic test (such as FR , VR , TT , TTR). Note: This does not stop logging – use Stop command to stop logging.	(press Esc key several times)
Diagnostic	Perform diagnostic tests on SBE 53. Tests are non-destructive – they do not write over any existing settings.	DS (status); DC (calibration coefficients); DD0,10 (upload and display tide samples 0 – 10); FR (display frequencies)

*See *Command Descriptions* in this section.

Note:
SeatermW's general communication baud rate must be the same as the SBE 53 baud rate (set with **Baud=**). Baud is factory-set to 9600, but can be changed by the user (see *Command Descriptions*). Other communication parameters – 8 data bits, 1 stop bit, and no parity – cannot be changed.

3. In the Communications menu, select Configure. The dialog box looks like this:

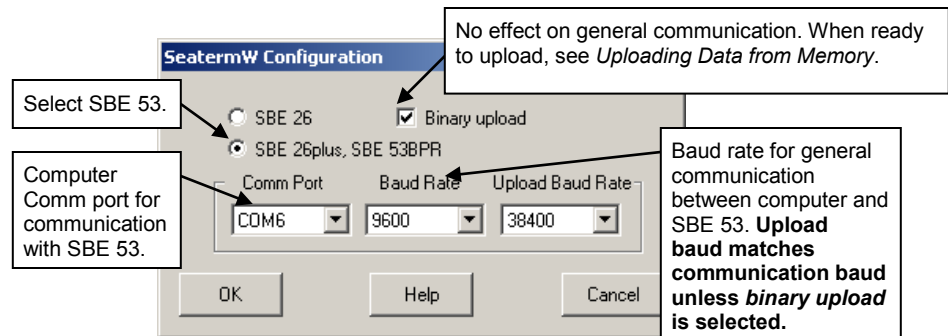

Verify/modify the parameters in the Configuration dialog box. Click OK.

4. In the Communications menu, select Connect. The display looks like this:

```
SBE 53 BPR
S>
```

Note:

The SBE 53 automatically enters quiescent (sleep) state after 2 minutes without receiving a command. This timeout algorithm conserves battery energy if the user does not send **QS** to put the SBE 53 to sleep. If the system does not appear to respond, select Connect in the Communications menu to reestablish communications.

This shows that correct communications between the computer and SBE 53 has been established.

If the system does not respond with the S> prompt:

- Select Connect again.
- Verify the correct instrument, Comm port, and baud rate were entered in the Configuration dialog box.
- Check cabling between the computer and SBE 53.

5. Display SBE 53 setup information by clicking Status; SeatermW sends the **DS** command. The display looks like this:

```
SBE 53 BPR V 2.1 SN 12345 05 Apr 2013 13:35:13
user info=test setup
quartz pressure sensor: serial number = 90319, range = 10000 psia
internal temperature sensor
conductivity = YES
iop = 6.0 ma vmain = 15.3 V vlith = 9.3 V
last sample: p = 21.9520, t = 21.0250, s = 34.3799

tide measurement: interval = 30 minutes, duration = 3 minutes, power pressure sensor continuously
measure reference frequency every 336 tide samples
logging start time = do not use start time
logging stop time = do not use stop time

tide samples/day = 48.000
memory endurance = 34952.5 days
nominal battery endurance = 523 days alkaline, 1521 days lithium
total recorded tide measurements = 0
total recorded reference frequency measurements = 0
tide measurements since last start = 0
transmit real-time tide data = YES

status = stopped by user
logging = NO, send start command to begin logging
```

6. Send the desired commands to set up the SBE 53 (see *Command Descriptions* below). Verify the setup by clicking Status again.

Notes:

- See *Appendix II: Sample Timing* for a detailed description of when tide measurements are made and stored in memory.
- When transmitting real-time tide data, each tide measurement record displays **after** the tide duration is complete. For example, if the tide duration is 10 minutes, the first tide data displays 10 minutes after logging starts.

7. Test the setup by typing **Start** and pressing the Enter key to begin logging.

If the **DS** response shows logging start time = do not use start time (*use start time?* in **SetSampling** prompt is *No*), the SBE 53 responds:

```
logging will start in 10 seconds
```

If the **DS** response shows transmit real-time tide data = YES (real-time tide data was enabled with **TxTide=Y**), each time the SBE 53 completes a tide measurement, the display looks like this:

```
Tide: start time = 05 Apr 2013 13:40:01, pr =14.2135,
pc = 14.2135, pt = 21.352, t = 21.0250, c = 4.81952,
s = 34.3799
```

where:

- start time = start of tide measurement.
- pr = stored raw pressure, converted to psia.
- pc = corrected pressure (not stored) converted to psia, with correction based on most recent measured reference frequency.
- pt = stored pressure temperature, converted to °C.
- t = stored temperature, converted to °C.
- c = stored conductivity, converted to S/m, and
s = calculated salinity (not stored) in psu.

Conductivity and salinity display only if **DS** response shows conductivity = YES (conductivity acquisition was enabled with **Conductivity=Y**).

8. End the test by typing **Stop** and pressing the Enter key to stop logging. You may need to press the Esc key before entering **Stop** to get the SBE 53 to stop if it is in the middle of sampling. Verify that logging has stopped by clicking Status and checking that the last line of the **DS** response shows logging = no.
9. (if ready for deployment)
- Type **InitLogging** and press the Enter key to make the entire memory available for recording. If **InitLogging** is not sent, data will be stored after the last recorded sample.
 - To begin logging now: Type **Start** and press the Enter key. The SBE 53 should display:
logging will start in 10 seconds.
 - To begin logging at a delayed start date and time:
 - Type **SetStartTime**, press the Enter key, and respond to the prompts to establish a delayed start date and time.
 - Type **SetSampling** and press the Enter key, and answer yes to the *use start time?* prompt to enable logging at the delayed start date and time.
 - Type **Start** and press the Enter key. The SBE 53 should display:
logging will start at . . .
10. (if not ready for deployment) Type **QS** and press the Enter key to command the SBE 53 to go to sleep (quiescent state).

Command Descriptions

This section describes commands and provides sample outputs.
See *Appendix I: Command Summary* for a summarized command list.

General Command Notes

- Input commands in upper or lower case letters and register commands by pressing the Enter key.
- The SBE 53 sends ? CMD if an invalid command is entered.
- If the SBE 53 does not return an S> prompt after executing a command, press the Enter key to get the S> prompt.
- If a new command is not received within 2 minutes after completion of a command, the SBE 53 returns to quiescent (sleep) state and the display indicates time out.
- If in quiescent state, re-establish communications by clicking Connect or pressing the Enter key to get an S> prompt.
- The SBE 53 cannot have samples with different tide sample scan lengths (more or fewer data fields per sample) in memory. If the scan length is changed, the SBE 53 must initialize logging. Initializing logging sets the tide sample number and reference frequency sample number to 0, so the entire memory is available for recording data with the new scan length. **Initializing logging should only be performed after all previous data has been uploaded.** Conductivity=, which enables/disables acquisition and storing of optional conductivity data, changes the scan length. Therefore, Conductivity= prompts the user for verification before executing, to prevent accidental overwriting of existing data.
- The SBE 53 responds only to **DS**, **DC**, **QS**, **SL**, **SLO**, and **Stop** while making a tide measurement. If you query the SBE 53 while it is logging (for example, to send **DS** to check on logging progress), it does not interrupt logging.
- The SBE 53 responds only to **DS**, **DC**, **QS**, and **Stop** while *waiting to start logging* (*use start time?* prompt in **SetSampling** command is **Yes**, and **Start** was sent, but sampling has not started yet).
To send any other commands:
 1. Send **Stop**.
 2. Send the desired commands to modify the setup.
 3. Send **Start** again.
- Click Upload to upload data that will be processed by Seasoft for Waves. Manually entering a data upload command does not produce data with the required header information for Seasoft for Waves.
- If the SBE 53 is uploading data and you want to stop it, press the Esc key or click Stop. Press the Enter key to get the S> prompt.

Note:

Interrupting a tide measurement by pressing the Esc key or clicking Stop will affect the quality of your data. For high quality data, Sea-Bird recommends setting sampling parameters with enough time between measurements to allow querying the SBE 53 during logging without interrupting measurements.

Entries made with the commands are permanently stored in the SBE 53 and remain in effect until you change them.

- The only exception occurs if the electronics are removed from the housing and the two PCBs are separated or the lithium jumper (JP7) is removed (see *Appendix IV: Electronics Disassembly/Reassembly*). Before beginning disassembly, upload all data in memory. Upon reassembly, reset the date and time (**SetTime**) and initialize logging (**InitLogging**).

Commands

Status Command

Note:

You can wake up the SBE 53 during a tide measurement and display status (press Enter key to get S>, then click Status) without interrupting logging.

Notes:

- **Memory** endurance is based on **total** memory capacity, taking into account the setup (measurement interval and duration), but not considering the measurements already in memory.
- **Battery** endurance is based on **original**, nominal battery capacity, taking into account the setup (measurement interval, duration, etc). It is not based on a measurement of remaining battery voltage or the number of measurements already taken. If calculated alkaline battery endurance is greater than 730 days, status response shows

```
deployments longer than
2 years are not recommended
with alkaline batteries.
```

Memory and battery endurance output with **DS** matches that calculated in Battery and Memory Endurance. See *Section 4: Pre-Deployment Planning – Battery and Memory Endurance*.

Note:

After sending **Start**, logging status should be one of the following if the SBE 53 is operating correctly:

- logging started - if **use start time** in **SetSampling** prompt is **No** (SBE 53 started logging 10 seconds after receipt of **Start**).
- waiting to start at . . .
 - if **use start time** in **SetSampling** prompt is **Yes** (SBE 53 waits to start logging at time set with **SetStartTime**).

DS

Display operating status and setup parameters. Equivalent to Status menu.

List below includes, where applicable, command used to modify parameter.

- Firmware version, serial number, date and time [**SetTime** or **DateTime**=]
- User-input description [**UserInfo**=]
- Pressure sensor type (quartz), serial number, and full scale range
- Enable high-accuracy external thermistor (factory-set)?
- Enable conductivity sensor [**Conductivity**=]?
- Main operating current, main and back-up lithium battery voltages
- Last measured raw (uncorrected) pressure (psia) and temperature (°C); calculated salinity (only if conductivity enabled, psu)
- Sampling setup [**SetSampling**]:
 - Interval between tide samples, tide sample duration, and pressure sensor power parameter (powered continuously, or warm-up time if not powered continuously)
 - Interval between reference frequency measurements;
 - Start time for logging (if enabled);
 - Stop time for logging (if enabled)
- Calculated number of tide samples/day [based on **SetSampling**]
- Calculated memory endurance [based on **SetSampling**]
- Calculated battery endurance [based on **SetSampling**]
- Number of tide measurements in memory
- Number of reference frequency measurements in memory
- Number of tide measurements since last start of logging
- Transmit real-time tide data [**TxTide**=]?
- Logging status is one of following:
 - never started
 - waiting to start at . . .
 - logging started
 - stop: out of memory
 - stop: low battery
 - stop time reached
 - stopped by user
 - unknown
- Logging is one of following:
 - NO, send start command to begin logging (if **Start** has not been sent)
 - YES (if **Start** has been sent and SBE 53 is currently logging)
 - YES, waiting to start (if **Start** has been sent but SBE 53 is programmed to start logging at a future date/time)

Status Command (*continued*)

Example: (user input in bold; parameter used to change value in parentheses).

```

S>>DS
SBE 53 BPR V 2.1  SN 12345   05 Apr 2013  13:35:13           [SetTime or DateTime=]
user info=test setup                                     [UserInfo=]
quartz pressure sensor: serial number = 90319, range = 10000 psia
internal temperature sensor                             [factory-set]
conductivity = YES                                     [Conductivity=]
iop = 6.0 ma  vmain = 15.3 V  vlith = 9.3 V
last sample: p = 21.9520, t = 21.0250, s = 34.3799

tide measurement: interval = 30 minutes, duration = 3 minutes, warmup = 15 minutes           [SetSampling]
measure reference frequency every 336 tide samples                                       [SetSampling]
logging start time = 29 Apr 2013 00:00:00                                               [SetSampling and SetStartTime]
logging stop time = 30 Apr 2013 00:00:00                                               [SetSampling and SetStartTime]

tide samples/day = 48.000                                                                [based on SetSampling]
memory endurance = 34952.5 days                                                         [based on SetSampling]
nominal battery endurance = 765 days alkaline, 2166 days lithium                       [based on SetSampling]
total recorded tide measurements = 0
total recorded reference frequency measurements = 0
tide measurements since last start = 0
transmit real-time tide data = YES                                                     [TxTide=]

status = stopped by user (see Notes)
logging = NO, send start command to begin logging

```

Notes:

1. You must send **Start** to start logging at programmed logging start time. After you send **Start**, status line should show:
status = waiting to start at 29 Apr 2013 00:00:00
2. If set up to continuously power pressure sensor and reference frequency oscillator during logging, tide measurement line looks like this:
tide measurement: interval = 30 minutes, duration = 3 minutes, power pressure sensor continuously

General Setup Commands**SetTime**

Set real-time clock date and time.
SBE 53 prompts for desired date and time.

Example: Set current date and time to 31 August 2013 12:35:00 (user input in bold).

```

S>>SETTIME
set current time:
month (1 - 12) = 8
day (1 - 31) = 31
year (4 digits) = 2013
hour (0 - 23) = 12
minute (0 - 59) = 35
second (0 - 59) = 0

```

DateTime=x

x= real-time clock date and time (mmddyyyhhmmss). Command is sent automatically when using SeatermW's DateTime menu. DateTime menu provides greater accuracy in setting time than can be achieved with **SetTime**; this may be important if you want to synchronize sampling among multiple instruments. See *Setting Time in SBE 53 to Synchronize Sampling of Multiple Instruments* below.

General Setup Commands (*continued*)

Note:

The SBE 53 baud rate for general communication (set with **Baud=**) must be the same as SeatermW's baud rate (set in the Configure menu).

Baud=x

x= baud rate for general communication (600, 1200, 2400, 4800, 9600, 19200, or 38400). Default 9600.

Note:

When **Conductivity=** is sent, the SBE 53 must initialize logging, setting tide sample number to 0, so the entire memory is available for recording data with the new scan length. **This should only be done after all previous data has been uploaded.** Therefore, the SBE 53 requires verification when **Conductivity=** is sent; the SBE 53 responds: `this command will change the scan length and initialize FLASH memory. Proceed Y/N?`
Press Y and the Enter key to proceed.

Conductivity=x

x=Y: Enable conductivity logging (use if SBE 53 includes optional SBE 4M conductivity sensor).

x=N: Disable conductivity logging.

UserInfo=x

x= user-defined string that displays in status (**DS**) reply. Can be up to 59 characters, including spaces; SBE 53 drops any characters after 59. No carriage returns are allowed. Allows user to include information describing deployment, conditions, etc. as permanent part of data set, because **DS** reply is included in uploaded .hex file when Upload in SeatermW is used to upload data (see *Uploading Data from Memory*).

TxTide=x**Note:**

Seasoft for Waves data processing modules cannot process real-time tide data from the SBE 53.

x=Y: Transmit real-time tide data while logging. Does not affect storing data to memory. SBE 53 transmits tide measurement start time, raw pressure (psia), corrected pressure (psia), pressure temperature (°C), and temperature (°C). If **Conductivity=Y**, it also transmits conductivity (S/m) and salinity (psu).

x=N: Do not transmit real-time tide data.

QS

Quit session and place SBE 53 in quiescent (sleep) state. Main power is turned off. Memory retention is not affected.

Note:

Drawing is schematic only, intended to define the sampling scheme terminology. See *Appendix II: Sample Timing* for timing details.

Tide Setup Command**SetSampling**

Set sampling parameters. SBE 53 displays present value and asks for new value for each parameter. Type in desired value and press Enter key. To accept present value without change, press Enter key. SBE 53 prompts as follows:

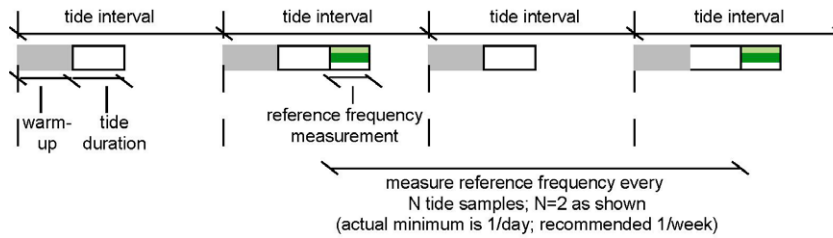
**Notes:**

- An alternate form for this command is **SetSample**; both have the same function.
- See *Appendix II: Sample Timing* for a detailed description of when tide measurements and reference frequency measurements are made.
- If (warmup + tide duration) > 59 minutes, SBE 53 sets tide interval to 60 minutes, tide duration to 44 minutes, and warmup to 15 minutes.
- The SBE 53 will not take any reference frequency measurements if **both** of the following conditions apply: (tide interval – tide duration) < 10 minutes **and** tide duration < 10 minutes,
- See *Making Corrections Using Reference Frequency Data* in *Appendix III: Data Formats* for the use of the reference frequency data in a pressure correction algorithm.

Continuously power pressure sensor (y/n) = n, new value =

If **Y**, SBE 53 continuously powers pressure sensor and reference frequency oscillator (recommended for highest quality data).

If **N**, SBE 53 powers down between measurements, reducing power consumption.

The following prompt appears only if you enter N above.

pressure sensor warmup (integer minutes) = 15, new value =

Warm-up time before pressure measurement, if pressure sensor and reference frequency oscillator not continuously powered. Minimum value 5 minutes; user-input outside range is set to minimum or maximum (see note) allowable value, as appropriate. Sea-Bird recommends 15 minutes or more for warm-up.

tide interval (integer minutes) = 30, new value =

Time from start of tide measurement to start of next tide measurement. Range 1 - 60 minutes; user-input outside range is set to minimum or maximum allowable value, as appropriate.

tide measurement duration (integer minutes) = 1, new value =

Length of tide measurement (SBE 53 integrates over this time, counting signal continuously and computing average pressure). Range 1 - 60 minutes. If tide duration > (tide interval – 10 sec), tide duration is set to tide interval, and SBE 53 samples tides continuously.

Measure reference frequency every N tide samples: N = 20,**new value =**

SBE 53 takes reference frequency measurement after every N tide samples, and uses this to establish pressure sensor drift. Sea-Bird recommends reference frequency measurement approximately 1/week; allowable values for N vary, depending on tide interval, and correspond to measuring reference frequency no more than 1/day to no less than 1/month.

Tide Setup Command (*continued*)

use start time (y/n) = n, new value =

If **Y**, SBE 53 responds to **Start** by starting logging at date and time set with **SetStartTime**.

If **N**, SBE 53 starts logging 10 seconds after **Start** is sent.

use stop time (y/n) = n, new value =

If **Y**, SBE 53 stops logging at date and time set with **SetStopTime**.

If **N**, SBE 53 continues logging until **Stop** is sent.

Use **DS** to verify that SBE 53 is set up to sample as desired.

Example (user input in bold): Set up SBE 53 to take 2-minute tide measurement (tide measurement duration = 2) every 60 minutes (tide interval = 60), to take 1 reference frequency measurement per day (once every 24 tide measurements), and to power the pressure sensor for a 15-minute warm-up before each measurement. Set up SBE 53 to start and stop sampling on command, rather than at pre-set start and stop times. Then send **DS** to verify setup.

```
S>SETSAMPLING
continuously power pressure sensor (y/n) = n, new value = n
pressure sensor warmup (integer minutes) = 10, new value = 15
tide interval (integer minutes) = 1, new value = 60
tide measurement duration (integer minutes) = 1, new value = 2
measure reference frequency every N tide samples: N = 20, new value = 24
use start time (y/n) = y, new value = n
use stop time (y/n) = n, new value = n
S>DS
SBE 53 BPR V 2.1 SN 12345 26 Apr 2013 13:21:13
user info=test setup
quartz pressure sensor: serial number = 90319, range = 10000 psia
internal temperature sensor
conductivity = YES
iop = 6.0 ma vmain = 15.3 V vlith = 9.3 V
last sample: p = 21.9520, t = 21.0250, s = 34.3799

tide measurement: interval = 60 minutes, duration = 2 minutes, warmup = 15 minutes
measure reference frequency every 24 tide samples
logging start time = do not use start time
logging stop time = do not use stop time

tide samples/day = 24.00
memory endurance = 67108.9 days
nominal battery endurance = 931 days alkaline, 2591 days lithium
total recorded tide measurements = 0
total recorded reference frequency measurements = 0
tide measurements since last start = 0
transmit real-time tide data = YES

status = stopped by user
logging = NO, send start command to begin logging
```

Initialize Logging (Reset Memory) Commands

Note:

Do not initialize logging until all data has been uploaded. InitLogging does not delete data; it resets the data pointer. **If you accidentally initialize logging before uploading**, recover data as follows:

For ASCII Upload:

1. Set **TideCount=a**, where **a** is your estimate of number of tide samples in memory.
2. Upload data. If **a** is more than actual number of tide samples, data for non-existent samples will be bad, random data. Review uploaded data carefully and delete any bad data.
3. If desired, increase **a** and upload data again, to see if there is additional valid data in memory.

For Binary Upload:

1. Set ***ByteCount=a**, where **a** is your estimate of number of bytes in memory.
2. Upload data. If **a** is more than actual number of bytes, data for non-existent samples will be bad, random data. Review uploaded data carefully and delete any bad data.
3. If desired, increase **a** and upload data again, to see if there is additional valid data in memory.

InitLogging

Initialize logging - after all previous data has been uploaded, initialize logging before starting to sample again to make entire memory available for recording.

InitLogging sets tide sample number and reference frequency sample number to 0 internally. If not set to 0, data will be stored after last recorded sample. **Do not send InitLogging until all existing data has been uploaded.**

The following two commands are typically used only if you accidentally initialize logging before uploading the data in memory.

TideCount=x

x= sample number for first tide measurement when sampling begins. Use **TideCount=** to recover data if you accidentally initialize logging before uploading, and will be doing an ASCII upload.

***ByteCount=x**

x= byte number for first byte when sampling begins. Use ***ByteCount=** to recover data if you accidentally initialize logging before uploading, and will be doing a binary upload.

Logging Commands

To start logging, send **Start**:

- If *Use start time?* in **SetSampling** prompt is *No*, logging starts approximately 10 seconds after receipt of **Start**.
- If *Use start time?* in **SetSampling** prompt is *Yes*, logging starts at the delayed time set with **SetStartTime**.

The first time logging starts after receipt of initialize logging (**InitLogging**), data recording starts at the beginning of memory and any previously recorded data is written over.

To stop logging:

- Send **Stop**, or
- Before starting logging, set a delayed stop time with **SetStopTime**, and set *Use stop time?* in **SetSampling** prompt to *Yes*.

Each time the SBE 53 is commanded to start logging again, recording continues, with new data stored after previously recorded data.

Notes:

- You can wake up the SBE 53 during a tide measurement and display status (press Enter key to get S>, then click Status) without interrupting logging.
- You may need to send **Stop** several times to get the SBE 53 to respond.
- You must stop logging before uploading data.
- If *Use start time?* in the **SetSampling** prompt is *Yes*, and **SetStartTime** is less than 10 seconds in the future when **Start** is sent, the SBE 53 ignores the programmed start time and starts logging in 10 seconds.
- If *Use stop time?* in the **SetSampling** prompt is *Yes*, and **SetStopTime** is less than 1 hour after logging begins, the SBE 53 ignores the programmed stop time and continues logging until **Stop** is sent.
- See *Setting Time in SBE 53 to Synchronize Sampling of Multiple Instruments* below to set multiple instruments to start logging at the same time.

Start

If *Use start time?* in **SetSampling** prompt is *No*: Start logging now (in approximately 10 seconds).

OR

If *Use start time?* in **SetSampling** prompt is *Yes*: Wait to start logging at time set with **SetStartTime**.

Stop

Stop logging.

SetStartTime

Set date and time to start logging. SBE 53 prompts you to enter desired date and time. Upon receipt of **Start**, SBE 53 waits to start logging at this date and time if *Use start time?* in **SetSampling** prompt is *Yes*.

SetStopTime

Set date and time to stop logging. SBE 53 prompts you to enter desired date and time. SBE 53 stops logging at this date and time if *Use stop time?* in **SetSampling** prompt is *Yes*.

Logging Commands (*continued*)

Example 1: Start and stop logging on command (user input in bold).

S>**SETSAMPLING**

. . . (Respond to prompts, changing tide sampling setup as desired.)

use start time (y/n) = y, new value = **n**

use stop time (y/n) = y, new value = **n**

S>**START**

Logging will start in 10 seconds

(If **TxTide=Y**, tide data displays on screen. See *Programming for Deployment - SeatermW* for a description of screen display while logging.)

(To stop logging, press Enter key several times to get S> prompt.)

S>**STOP**

Example 2: Program SBE 53 to start logging on 20 August 2013 12:35:00 and stop logging on 21 August 2013 12:35:00 (user input in bold).

S>**SETSAMPLING**

. . . (Respond to prompts, changing tide sampling setup as desired.)

use start time (y/n) = n, new value = **y**

use stop time (y/n) = n, new value = **y**

S>**SETSTARTTIME**

Set time to start logging:

Month (1-12) = **8**

Day (1 - 31) = **20**

Year (4 digits) = **2013**

Hour (0 - 23) = **12**

Minute (0 - 59) = **35**

Second (0 - 59) = **0**

S>**SETSTOPTIME**

Set time to stop logging:

Month (1-12) = **8**

Day (1 - 31) = **21**

Year (4 digits) = **2013**

Hour (0 - 23) = **12**

Minute (0 - 59) = **35**

Second (0 - 59) = **0**

S>**START**

Logging will start at 20 August 2013 12:35:00

Logging will stop at 21 August 2013 12:35:00

(When logging starts: If **TxTide=Y**, tide data displays on screen. See *Programming for Deployment - SeatermW* for a description of screen display while logging.)

(Logging stops at time set with **SetStopTime**.)

Send Last Sample Commands

Notes:

- See *General Command Notes* above for issues relating to sending commands while the SBE 53 is making a tide measurement.
- See *Making Corrections Using Reference Frequency Data* in *Appendix III: Data Formats* for pressure correction algorithm.

These commands cause the SBE 53 to transmit data from the last tide measurement in memory:

- pr = stored raw pressure, converted to psia.
- pc = corrected pressure (not stored) converted to psia, with correction based on most recent measured reference frequency.
- t = stored temperature, converted to °C.
- s = calculated salinity (computed from stored temperature and conductivity) in psu. Displays only if **DS** response shows conductivity = YES (conductivity acquisition was enabled with **Conductivity=Y**).
- date/time stored in memory with the data.

These commands are functional only while the SBE 53 is logging (after **Start** has been sent to start logging now or at a future date/time).

- If **Start** has not been sent, the SBE 53 responds with ? CMD.
- If **Start** has been sent, but there is not yet a completed tide measurement in memory, the SBE 53 responds with:

```
pr = -99.0000, pc = -99.0000, t = -99.0000, s = -99.0000
```

SL Send data from last tide measurement and remain ready for another command (command mode).

SLO Send data from last tide measurement and exit command mode. Equivalent to sending **SL** and then **QS**.

Example: (user input in bold).

```
S>SL
pr = 14.5266, pc= 14.5266, t = 22.7003, s = 29.05335, 06 Jul 2006 08:30:00
```

Data Upload Commands

Stop logging before uploading data from memory.

ASCII Upload:

DD Upload all data **in ASCII** at baud rate set for general communication with **Baud=**.

Binary Upload:

Binary upload, useful for large data sets, is inherently faster than ASCII upload, because each byte is transmitted as one character instead of two. Additionally, the SBE 53 supports binary upload at rates up to 115,200 baud, compared to ASCII upload at rates up to 38,400. SeatermW uploads the data in binary and then converts to ASCII, **resulting in a .hex file with the same format as from an ASCII upload.**

DBbaud,b,e Upload data **in binary** at **baud** rate (1200, 2400, 4800, 9600, 19200, 28800, 38400, 57600, or 115200) from byte **b** to **e**. First byte number is 0. SBE 53 can upload data in blocks of up to 500,000 bytes at one time. **Sending this command manually does not provide useful information.**

ByteCount Display total number of bytes in memory.

Notes:

- Use SeatermW's Upload menu to upload data in ASCII or binary to a .hex file that will be processed by Seasoft for Waves' Convert Hex module (see *Uploading Data from Memory* below). Manually entering **DD** or **DBbaud,b,e** does not produce data with the required header information for processing by Seasoft for Waves. These commands are included here for reference for users who are writing their own software.
- To save manually uploaded data to a file, click Capture before entering the upload command.
- When SeatermW's Upload menu is used for binary upload, SeatermW automatically tests that the selected upload baud rate is compatible with your computer, sends **ByteCount**, and sends **DBbaud,b,e** as many times as needed to upload all the data in memory in blocks of 500,000 bytes.

Diagnostic Commands

Data from these tests is not stored in FLASH memory.

Notes:

- Pressure output using **TS** or **TSR** is not very accurate, because SBE 53 turns on power to the pressure sensor immediately before taking the measurement (pressure sensor requires warm-up for accurate results).
- Conductivity and salinity are output only if conductivity is enabled (**Conductivity=Y**).

TS	Take 1 sample of pressure, pressure temperature, temperature, and optional conductivity, and output converted data (raw pressure psia, pressure temperature °C, temperature °C, conductivity S/m, salinity psu, date and time).
TSR	Take 1 sample of pressure, pressure temperature, temperature, and optional conductivity, and output raw data (raw pressure frequency Hz, pressure temperature frequency Hz, temperature A/D counts, and conductivity frequency Hz).
TT	Sample temperature, and output converted data (°C). SBE 53 runs continuously during test, drawing current. Press Esc key or click Stop to stop test.
TTR	Sample temperature, and output raw data (A/D counts). SBE 53 runs continuously during test, drawing current. Press Esc key or click Stop to stop test.
FR	Sample conductivity, and output raw data (frequency Hz). Displays only if conductivity enabled with Conductivity=Y . SBE 53 runs continuously during test, drawing current. Press Esc key or click Stop to stop test.

Diagnostic Commands (*continued*)**VR**

Measure and display power:

Column	Output
1	Main battery voltage / 11.18
2	Back-up lithium voltage / 4.8187
3	Operating current (mA) / 20.04
4	Ground voltage

SBE 53 runs continuously during test, drawing current. Press Esc key or click Stop to stop test.

***FlashInit**

Map bad blocks and erase FLASH memory (2048 blocks), **destroying all data**. SBE 53 requires you to enter ***FlashInit** twice, to provide verification before it proceeds. All data bits are set to 1. Tide sample number is set to 0. **Test takes approximately 1 hour, and cannot be interrupted once it has started.**

Send ***FlashInit** (after uploading all data) if there are FLASH Read errors in Status (**DS**) response. If not encountering errors, use of command is optional, as SBE 53 writes over previously recorded information when **InitLogging** is used before beginning sampling. However, knowledge of initial memory contents (i.e., all 1's) can be a useful cross-check when data is retrieved.

***FlashGood**

Display number of good blocks in FLASH memory (should be 2008 to 2048 blocks, with each block 16K bytes). If number of good blocks not in this range, consult factory.

Calibration Coefficients Commands

Notes:

- Dates shown are when calibrations were performed. Calibration coefficients are initially factory-set and should agree with Calibration Certificates shipped with SBE 53.
- See individual commands below to modify calibration coefficients.
- Calibration coefficients are applied to the raw data to output real-time and queried (**SL**, **SLO**, and some testing commands) data in engineering units.
- Pressure, temperature, and conductivity are stored in memory as raw data, before application of the calibration coefficients, and the data is uploaded from memory to a .hex file as raw data. The .hex file also contains the **DC** command and response. Convert Hex uses the calibration coefficients in the **DC** response to convert the raw data to engineering units. Pressure slope, and **an additional pressure offset**, are entered in Convert Hex's Coefficient Configuration dialog box to make small post-deployment corrections for pressure sensor drift. Note that the pressure offset entered in Convert Hex is *in addition to* the offset shown in the **DC** response.

See *Section 6: Conversion into Tide and Reference Frequency Files – Convert Hex*; also see *Sensor Calibration in Section 9: Routine Maintenance and Calibration*.

DC

Display calibration coefficients.

Example: (user input in bold).

S>DC

Pressure coefficients: 15-apr-2013

U0 = 5.818158e+00
 Y1 = -3.912547e+03
 Y2 = -1.192010e+04
 Y3 = 0.000000e+00
 C1 = -6.273148e+03
 C2 = 1.688132e+02
 C3 = 1.655105e+04
 D1 = 7.040300e-02
 D2 = 0.000000e+00
 T1 = 2.992117e+01
 T2 = 6.588880e-01
 T3 = 4.158092e+01
 T4 = 1.073818e+02

Offset = 0.000000e+00

(psia)

FRA0 = 4.915200000e+06
 FRA1 = 2.313499176e-01
 FRA2 = 2.313499176e-01
 FRA3 = 1.590508907e-09
 FRA4 = -4.979895771e-14
 FRA5 = 7.918649300e-19
 FRA6 = -5.031461328e-24

Temperature coefficients: 15-apr-2013

TA0 = -1.653843e-05
 TA1 = 2.800270e-04
 TA2 = -2.759926e-06
 TA3 = 1.646110e-07

Conductivity coefficients: 05-nov-2012

(only if **Conductivity=Y**)

CG = -8.000000e+00
 CH = 1.483257e+00
 CI = -1.931111e-04
 CJ = 9.170722e-05
 CTCOR = 3.250000e-06
 CPCOR = -9.570000e-08
 CSLOPE = 1.000000e+00

The individual Coefficients Commands listed below are used to modify a particular coefficient or date:

Note:

F = floating point number
S = string with no spaces

Pressure

PCalDate=S	S=calibration date.
PU0=F	F=U0.
PY1=F	F=Y1.
PY2=F	F=Y2.
PY3=F	F=Y3.
PC1=F	F=C1.
PC2=F	F=C2.
PC3=F	F=C3.
PD1=F	F=D1.
PD2=F	F=D2.
PT1=F	F=T1.
PT2=F	F=T2.
PT3=F	F=T3.
PT4=F	F=T4.
POffset=F	F=pressure offset (psia).
FRA0=F	F=reference frequency A0.
FRA1=F	F=reference frequency A1.
FRA2=F	F=reference frequency A2.
FRA3=F	F=reference frequency A3.

Temperature

TCalDate=S	S=calibration date.
TA0=F	F=A0.
TA1=F	F=A1.
TA2=F	F=A2.
TA3=F	F=A3.

Conductivity

CCalDate=S	S=calibration date.
CG=F	F=G.
CH=F	F=H.
CI=F	F=I.
CJ=F	F=J.
CTCor=F	F=TCOR.
CPCor=F	F=PCOR.
CSlope=F	F=Slope correction.

Setting Time in SBE 53 to Synchronize Sampling of Multiple Instruments

Note:

Software to provide accurate time on your computer is not supplied by Sea-Bird.

If you are running software on your computer that provides the computer with an accurate real-time stamp, the **DateTime** menu in SeatermW allows you to set the date and time in the SBE 53 to an accuracy of ± 25 msec of the time provided by the timekeeping software. This may be useful if you plan to deploy several instruments, and want to coordinate sampling so that each SBE 53 measures tides and waves on exactly the same schedule. Coordinating sampling can be accomplished by:

- Setting the time in each instrument accurately, using the **DateTime** menu,
- Setting up each instrument to sample at the same intervals and durations, and
- Setting up each instrument to start sampling at a delayed date and time – using the same start date and time for each instrument.

Set accurate time and coordinate sampling as follows:

1. In SeatermW, click **DateTime**. The following dialog box appears:

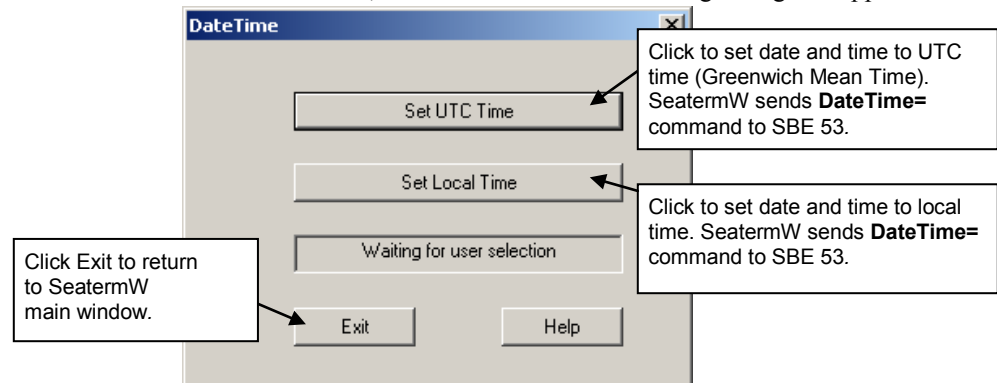

Click the desired time setting (UTC or local time). SeatermW sends the **DateTime=** command to the SBE 53, using the computer date and time. Click **Exit**.

2. If desired, set up the SBE 53 to start logging at some time in the future, allowing you to coordinate sampling to begin in multiple instruments at the same time:
 - Send the **SetStartTime** command to the SBE 53. The SBE 53 prompts you to enter the desired start date and time.
 - Send the **SetSampling** command. Set up the desired sampling scheme, and enter **Y** in response to the *Use start time?* prompt.

Installing and Deploying SBE 53

CAUTIONS:

- Do not use WD-40 or other petroleum-based lubricants, as they will damage the connector.
- For wet-pluggable MCBH connectors: **Silicone lubricants in a spray can** may contain ketones, esters, ethers, alcohols, or glycols in their propellant. **Do not use these sprays, as they will damage the connector.**

1. Install a cable (if transmitting real-time tide data) or dummy plug for the data I/O connector on the SBE 53 end cap:
 - A. Lightly lubricate the inside of the cable connector/plug with silicone grease (DC-4 or equivalent).
 - B. **XSG Connector** - Install the connector/plug, aligning the raised bump on the side of the plug with the large pin (pin 1 – ground) on the SBE 53. Remove any trapped air by *burping* or gently squeezing the plug near the top and moving your fingers toward the end cap.
OR
MCBH Connector – Install the connector/plug, aligning the pins.
 - C. Place the locking sleeve over the connector/plug. Tighten the locking sleeve finger tight only. **Do not overtighten the locking sleeve and do not use a wrench or pliers.**
2. If not using the SBE 4M conductivity sensor, install a dummy plug and locking sleeve on the SBE 53 3-pin bulkhead connector. Use the technique described in Step 1 for lubricating and burping an XSG connector.
3. (Optional) Install the SBE 4M conductivity sensor:
 - A. Mount the SBE 4M to the SBE 53 with the supplied mounting bracket, positioning the SBE 4M connector towards the conductivity connector on the SBE 53.
 - B. Connect the SBE 4M to the SBE 53 with the supplied cable, using the technique described in Step 1 for lubricating and burping an XSG connector, and then installing the locking sleeve.
 - C. Remove the Tygon tubing that was looped end-to-end around the SBE 4M conductivity cell to keep the cell clean while stored.
 - D. See *Application Note 70: Installing Anti-Foulant Device Mount Kit on SBE 4, 16, 19, and 21 Conductivity Cells* and *Appendix V: AF24173 Anti-Foulant Device*.

Note:

Acquisition of conductivity data must be enabled by sending **Conductivity=Y** in SeatermW when programming the SBE 53 for deployment.

Recovering SBE 53

WARNING!

If the SBE 53 stops working while underwater, or shows other signs of flooding or damage, carefully secure it away from people until you have determined that abnormal internal pressure does not exist or has been relieved. Pressure housings may flood under pressure due to dirty or damaged o-rings, or other failed seals. When a sealed pressure housing floods at great depths and is subsequently raised to the surface, water may be trapped at the pressure at which it entered the housing, presenting a danger if the housing is opened before relieving the internal pressure. Instances of such flooding are rare. However, a housing that floods at 5000 meters depth holds an internal pressure of more than 7000 psia, and has the potential to eject the end cap with lethal force. A housing that floods at 50 meters holds an internal pressure of more than 85 psia; this force could still cause injury.

If you suspect the SBE 53 is flooded, point it in a safe direction away from people, and loosen the 3 screws on the connector end cap about ½ turn. If there is internal pressure, the end cap will *follow* the screws out, and the screws will not become easier to turn. In this event, loosen 1 bulkhead connector very slowly, at least 1 turn. This opens an o-ring seal under the connector. Look for signs of internal pressure (hissing or water leak). If internal pressure is detected, let it bleed off slowly past the connector o-ring. Then, you can safely remove the end cap.

Rinse the SBE 53 with fresh water. See *Section 9: Routine Maintenance and Calibration* for (optional) conductivity cell cleaning and storage.

Uploading Data from Memory

The SBE 53 can upload data in ASCII at baud rates up to 38,400, or in binary at baud rates up to 115,200. Binary upload at 115,200 is approximately **six times faster** than ASCII upload at 38,400, because each byte is one character in binary but two characters in ASCII. Binary upload of the full memory (32 MB) at 115,200 baud requires approximately 3.5 hours. If binary upload is selected, SeatermW uploads the data in binary and then converts the data to ASCII, resulting in a .hex data file that is identical to one uploaded in ASCII.

1. In Seasoft for Waves' Run menu, select SeatermW. SeatermW appears.
2. Select Configure in the Communications menu. The Configuration dialog box appears. Verify/modify the instrument, Comm port, and baud rate, and whether to upload in binary (if *binary upload* is selected) or in ASCII.

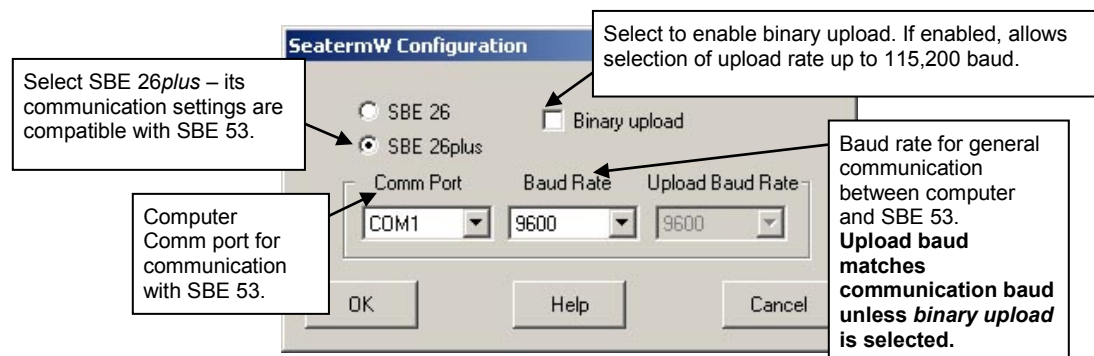

Click OK.

3. Select Connect in the Communications menu. The `S>` displays. This shows that correct communications between the computer and SBE 53 has been established.

If the system does not respond with the `S>` prompt:

- Select Connect again.
- Verify the correct instrument, Comm port, and baud rate were selected.
- Check cabling between the computer and SBE 53.

4. If the SBE 53 is still logging, command it to stop logging by typing **Stop** and pressing the Enter key. You may need to press the Esc key before entering **Stop** to get the SBE 53 to stop if it is in the middle of sampling.

5. Display SBE 53 status information by clicking Status. The status response should indicate `logging = no`.

Note:

The SBE 53 communicates at 9600 baud (factory-set default), 8 data bits, 1 stop bit, and no parity, as documented on the instrument Configuration Sheet. Baud rate can be changed with **Baud=**; other parameters cannot be modified.

6. Click Upload to upload stored data in a form that Seasoft for Waves' data processing modules can use. SeatermW responds as follows:
 - A. SeatermW sends the status (**DS**) command, displays the response, and writes the command and response to the upload file, with each line preceded by *. **DS** provides information regarding the number of samples in memory, tide interval, etc.
 - B. SeatermW sends the calibration coefficients (**DC**) command, displays the response, and writes the command and response to the upload file, with each line preceded by *. **DC** provides information regarding the sensor calibration coefficients.
 - C. In the Save As dialog box, enter the desired upload file name and click OK. The upload file has a .hex extension.
 - D. **ASCII Upload** (if binary upload was not selected in Step 2) – SeatermW sends the data upload command (**DD**). SeatermW writes the data to the upload file. The Status bar at the bottom of the SeatermW window displays the progress of the upload, indicating the number of uploaded lines of data.
 - E. **Binary Upload** (if binary upload was selected in Step 2) – SeatermW tests that the selected binary upload baud rate is supported by your computer. If it is not, the upload is aborted. SeatermW sends **ByteCount** to determine how many bytes of data are in memory, because only 500,000 bytes can be uploaded in one block. SeatermW sends the data upload command (**DBbaud,b,e**), as many times as needed to upload all the data in memory in blocks of 500,000 bytes. SeatermW converts the binary data back to ASCII, and writes the data to the upload file. The Status bar at the bottom of the SeatermW window displays the progress of the upload, indicating the number of uploaded lines of data.
7. Type **QS** and press the Enter key to put the SBE 53 in quiescent (sleep) state until ready to redeploy.
8. Ensure all data has been uploaded by processing the data. See *Section 6: Conversion into Tide and Reference Frequency Files – Convert Hex*.

Note:

Although SeatermW sends **DBbaud,b,e** to upload data in binary, the uploaded .hex file shows the **DD** command, so the file looks exactly the same, regardless of whether ASCII or binary upload was used.

Section 6: Conversion into Tide and Reference Frequency Files – Convert Hex

Notes:

- The first time you run Convert Hex, the Coefficients dialog box (Step 2 below) appears first.
- If you run Convert Hex from the command line with the `-t` command line option, Convert Hex adds diagnostic information to the output .tid file. See *Tide Data Format* in *Appendix III: Data Formats*.

Convert Hex converts uploaded hex (.hex) data into a tide (.tid) file with data in ASCII engineering units, and a reference frequency (.ref) file. Convert Hex must be run before further processing by Seasoft for Waves.

1. In Seasoft for Waves' Run menu, select Convert Hex. The dialog box looks like this:

.hex file uploaded from SBE 53 memory. Click Browse to search for file, or type in path and file name.

Desired path and file names for output tide (.tid) file. Convert Hex uses same path and file name (with different extension) for output reference frequency (.ref) file. Default path and file name is same as input .hex file. If desired, type in path and file name to change it from default.

Output wave (.wb) file **not applicable to SBE 53**.

.psa file contains calibration coefficients to make small corrections for pressure sensor drift between calibrations. Click Coefficients to view or modify coefficients or search for different file.

Conversion status bar.

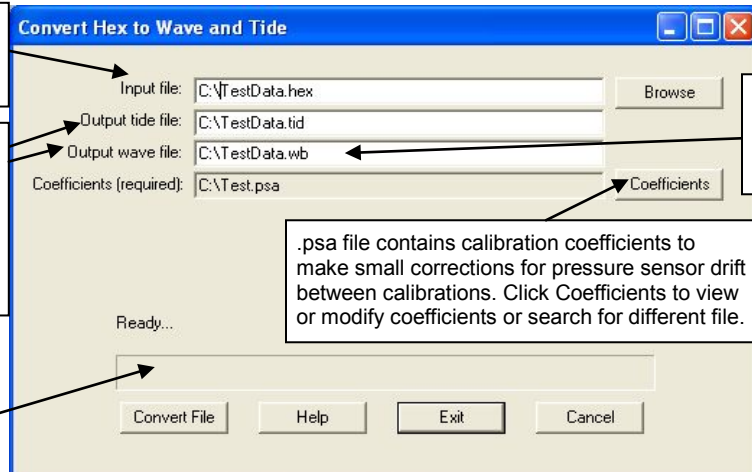

Note:

SeasoftWaves.ini contains the location and file name of the last saved .psa file for each module. SeasoftWaves.ini is stored in %USERPROFILE%\Local Settings\Apps\Sea-Bird (Example C:\Documents and Settings\dbresko\Local Settings\Apps\Sea-Bird)

Enter information in the dialog box. Click Coefficients to enter / verify calibration coefficients for converting hex data to engineering units.

2. The Coefficients dialog box looks like this:

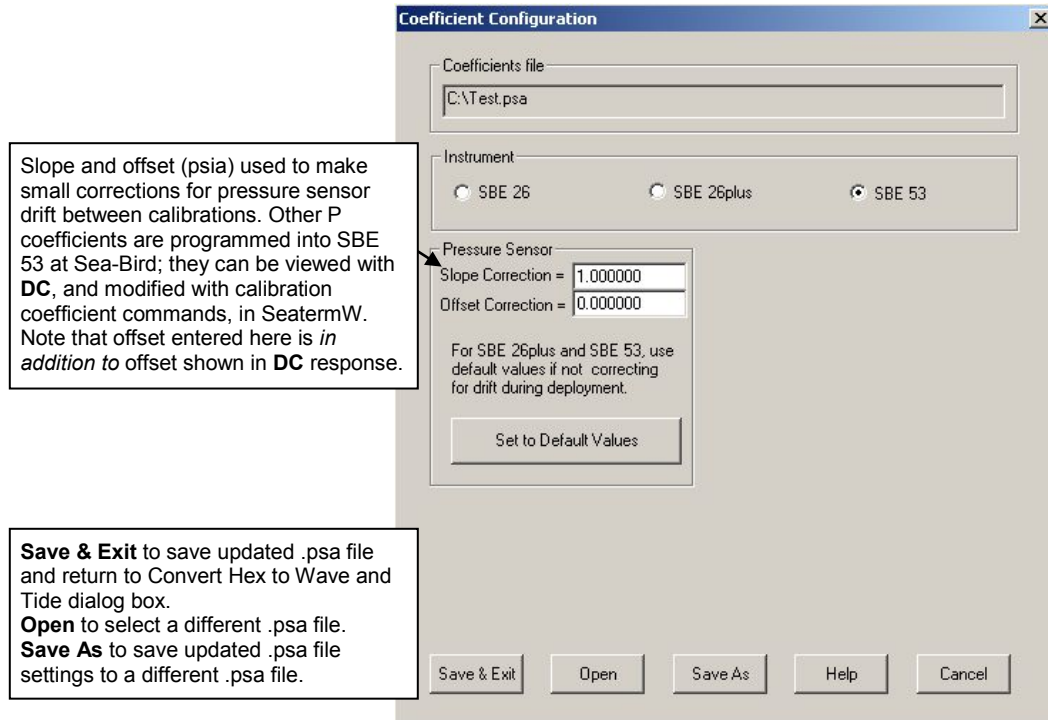

Make desired changes. Click OK to return to Convert Hex to Wave and Tide dialog box.

3. Click *Convert File* to process the data. The Status bar at the bottom of the dialog box shows the progress of the calculations; when completed, the Status bar shows *Finished conversion*.

Section 7: Tide Data Processing – Merge Barometric Pressure

Note:

The barometric pressure (.bp) file is **not** supplied by Sea-Bird. It is created by the user, based on local barometric pressure data (such as that from a local weather station). See *Input Barometric Pressure File Format* below for the required data format.

Merge Barometric Pressure reads in a tide (.tid) file (created with Convert Hex) and a barometric pressure (.bp) file, and subtracts barometric pressure from the tide data. The time in the files does not need to be aligned – Merge Barometric Pressure uses linear interpolation to align the data in time before subtracting barometric pressure. Merge Barometric Pressure can also convert tide pressure to water depth in meters, using average density and gravity.

Both the input tide data and output adjusted file have a .tid extension. However, Merge Barometric Pressure will not process a .tid file that it has already processed, preventing a user from erroneously removing barometric pressure multiple times from the tide data.

Remove barometric pressure as follows:

1. In Seasoftware for Waves' Run menu, select Merge Barometric Pressure. The File Setup tab looks like this:

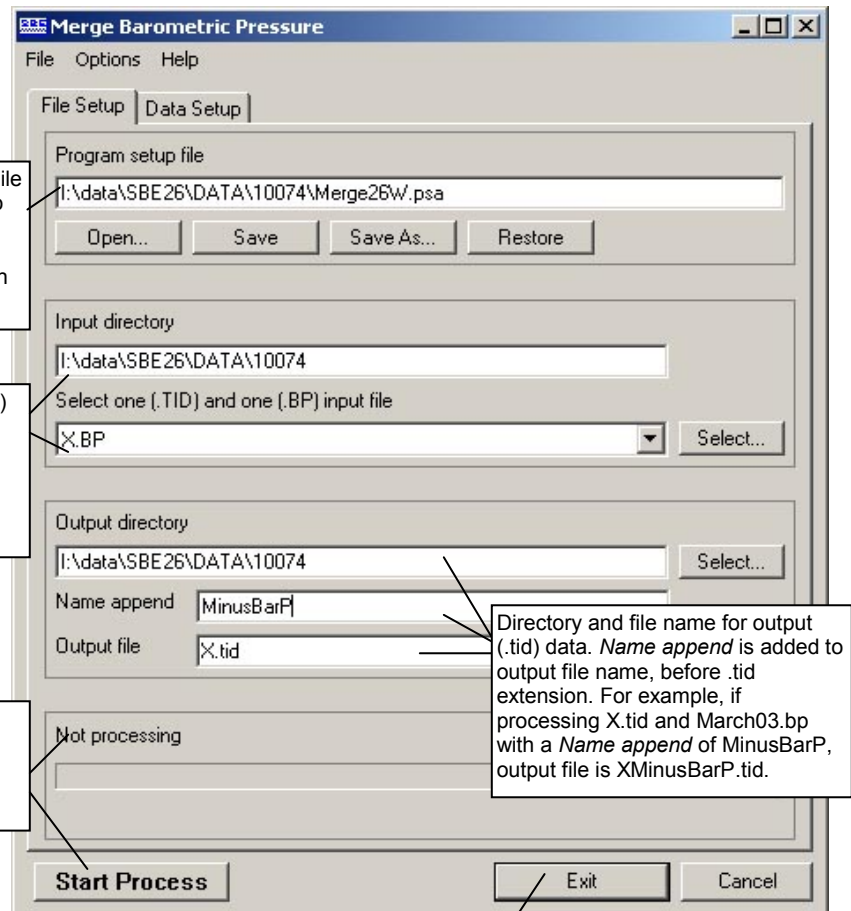

Note:

SeasoftwareWaves.ini contains the location and file name of the last saved .psa file for each module. SeasoftwareWaves.ini is stored in %USERPROFILE%\Local Settings\Apps\Sea-Bird (Example C:\Documents and Settings\dbresko\Local Settings\Apps\Sea-Bird)

File to store all information input in File Setup and Data Setup tabs. **Open** to select a different .psa file, **Save** or **Save As** to save current settings, or **Restore** to reset all settings to match last saved version.

Directory and file names for tide (.tid) data and barometric pressure (.bp) data. Note that both .tid and .bp files must be in same directory, but they can have different names. **Select** to pick different files.

Click **Start Process** to begin processing data. Status field shows *Processing complete* when done.

Directory and file name for output (.tid) data. *Name append* is added to output file name, before .tid extension. For example, if processing X.tid and March03.bp with a *Name append* of MinusBarP, output file is XMinusBarP.tid.

Return to Seasoftware for Waves window.

- If *Confirm Program Setup Change* was selected in Options menu - If you made changes and did not Save or Save As, program asks if you want to save changes.
- If *Confirm Program Setup Change* was not selected in Options menu - This button says **Save & Exit**. If you do not want to save changes, use Cancel button to exit.

Make the desired selections.

2. Click on the Data Setup tab. The Data Setup tab looks like this:

If selected, output .tid file contains water depth in place of pressure.

Units in input barometric pressure (.bp) file – psia or millibars.

Average density and gravity value to use to calculate water depth. Entries ignored if you do not select *Convert Pressure to Water Depth*.

Click **Start Process** to begin processing data. Status field on File Setup tab shows *Processing complete* when done.

Return to Seasoft for Waves window.

- If *Confirm Program Setup Change* was selected in Options menu - If you made changes and did not Save or Save As, program asks if you want to save changes.
- If *Confirm Program Setup Change* was not selected in Options menu - This button says **Save & Exit**. If you do not want to save changes, use Cancel button to exit.

Make the desired selections and click *Start Process* to process the data.

Note:

Merge Barometric Pressure adds descriptive headings to the pressure (or depth), temperature, and optional conductivity and salinity columns. The presence of headings in the .tid file indicates that it has been processed by Merge Barometric Pressure. See *Appendix III: Data Formats*.

Input Barometric Pressure File Format

Note:

The barometric pressure (.bp) file is **not** supplied by Sea-Bird. It is created by the user, based on local barometric pressure data (such as that from a local weather station).

The required format for the input barometric pressure (.bp) file is:

```
MM/DD/YY HH:MM:SS P
MM/DD/YY HH:MM:SS P
```

where

MM = month DD = day YY = year
 HH = hour MM = minute SS = second
 P = barometric pressure in psia or millibars

(1 standard atmosphere = 14.7 psia or 1013.5 millibars)

Example .bp File:

```
07/01/12 00:00:00 1015.5
07/01/12 01:00:00 1016.4
07/01/12 02:00:00 1017.3
```

Merge Barometric Pressure Algorithm

The linear interpolation algorithm is:

$$p_{bp} = p_0 + [(t - t_0) * (p_1 - p_0) / (t_1 - t_0)]$$

$$\text{corrected pressure} = p - p_{bp}$$

where

t = time of tide sample in .tid file
 p = pressure in .tid file at time t
 t₀ = latest time in .bp file that is less than or equal to t
 p₀ = barometric pressure at time t₀
 t₁ = earliest time in .bp file that is greater than or equal to t
 p₁ = barometric pressure at time t₁
 p_{bp} = interpolated barometric pressure

Depth is calculated as:

$$\text{depth} = \text{corrected pressure} / (\text{average density} * \text{gravity})$$

See Appendix VI: *Pressure-to-Depth Conversion*.

Section 8: Data Plotting – Plot Data

Plot Data displays and plots data from files with a .tid file extension:

- Plots up to five variables on one plot, with one X axis and up to four Y axes.
- Zooms in on plot features.
- Sends plots to a printer, saves plots to the clipboard for insertion in another program (such as Microsoft Word), or saves plots as graphic files in bitmap, metafile, or JPEG format.

Note:

SeasoftWaves.ini contains the location and file name of the last saved .psa file for each module. SeasoftWaves.ini is stored in %USERPROFILE%\Local Settings\Apps\Sea-Bird (Example C:\Documents and Settings\dbresko\Local Settings\Apps\Sea-Bird)

In Seasoft for Waves' Run menu, select Plot Data. Each tab of the Plot Data dialog box is described below, as well as options for viewing, printing, and saving a plot.

File Setup Tab

The File Setup tab defines the Program Setup file, input data file(s), and output plot file name. The File Setup tab looks like this:

File to store all information input in File, Plot, and Axis tabs. **Open** to select a different .psa file, **Save** or **Save As** to save current settings, or **Restore** to reset all settings to match last saved version.

Directory and file names for input data file (.tid). **Select** to pick different file.

Default directory and file name (can be changed while viewing plot) for outputting graphic file in .wmf, .jpg, or .bmp format. Default file name is set to match input file name, with additional characters added before extension, in order listed below:

- *Name append*, to allow user to add descriptive information to file name.
- Plot type (*tts* for Tide Time Series).

For example, if processing p.tid with a Name Append of Color and outputting .jpg file, output file name is pColorTts.jpg (Tide Time Series).

Click **Start Process** to begin processing data. Status field shows *Processing complete* when done.

Return to Seasoft for Waves window.

- If *Confirm Program Setup Change* was selected in Options menu - If you made changes and did not Save or Save As, program asks if you want to save changes.
- If *Confirm Program Setup Change* was not selected in Options menu - This button says **Save & Exit**. If you do not want to save changes, use Cancel button to exit.

Plot Setup Tab

The Plot Setup tab defines the plot type, data to be included, and plot layout (title, color, font, grid lines, etc.). The Plot Setup tab looks like this:

The screenshot shows the 'Plot Data' dialog box with the 'Plot Setup' tab selected. The dialog has a menu bar with 'File', 'Options', and 'Help'. Below the menu bar are tabs for 'File Setup', 'Plot Setup', 'X Axis', 'Y Axis 1', 'Y Axis 2', and 'Y Axis 3'. The 'Plot Setup' tab contains the following settings:

- Plot type:** A dropdown menu set to 'Tide Time Series'. A callout box notes: 'Tide Time Series only available selection if a .tid file was selected on File Setup tab.'
- Plot title:** A text field containing 'Tide Time Series Plot'.
- Title Color:** A color selection button (black) and a checkbox labeled 'Add file name to title' which is checked.
- Font type:** A dropdown menu set to 'Arial'. To its right is a preview box showing 'AaBbCcDdEeFf-012345'. A callout box explains: 'Plot Font type and Font size (small, medium, or large). Plot Data displays example of font type to right of selection. List of fonts depends on what fonts are installed on your computer.'
- Font size:** A dropdown menu set to 'Small'.
- Grid lines:** A dropdown menu set to 'Horizontal and Vertical'. A callout box explains: 'Grid lines (none, horizontal and vertical, horizontal, vertical). Grid style (solid, dotted, or dashed line), and whether to place Grid in front of plotted data.'
- Grid style:** A dropdown menu set to 'Thin Solid Line'.
- Grid in front:** An unchecked checkbox.
- Inside Background Color:** A color selection button (white).
- Outside Background Color:** A color selection button (white).
- Inside Background Color:** A callout box explains: 'Inside Background Color defines color within axes. Outside Background Color defines color outside axes.'
- Symbol size:** A dropdown menu set to 'Small'.
- Symbol frequency:** A numeric spinner set to '6'. A callout box explains: 'Symbol plotting frequency (0 = least frequent, 9 = most frequent), if Monochrome plot selected. If too frequent, symbols create illusion of very thick line, making details difficult to see.'
- Monochrome plot:** An unchecked checkbox.
- Plot symbols only:** An unchecked checkbox.
- Show line legends:** An unchecked checkbox.
- Mark data points:** An unchecked checkbox.
- Show plot shadow:** An unchecked checkbox. A callout box explains: 'Mark data points: Mark each individual data point with a dot, and connect dots. If not selected, Plot Data just draws a continuous line between data points. Show plot shadow: Create shadow effect to bottom and right of axes.'
- Auto range padding %:** A numeric spinner set to '5'.
- Process Options...:** A button. A callout box explains: 'Space between axes & maximum & minimum plotted values, if Auto range selected on Axis tabs. For 0%, maximum & minimum values plot on axes. Select number of tide scans to process and number to skip at start of data file. Default is to process all data.'
- Start Process:** A button. A callout box explains: 'Click Start Process to begin processing data. Status field shows Processing complete when done.'
- Exit:** A button. A callout box explains: 'Return to Seasoft for Waves window. If Confirm Program Setup Change was selected in Options menu - If you made changes and did not Save or Save As, program asks if you want to save changes. If Confirm Program Setup Change was not selected in Options menu - This button says Save & Exit. If you do not want to save changes, use Cancel button to exit.'
- Cancel:** A button.

X Axis Tab

Click on the X Axis tab. The X Axis tab defines the plot style as well as the X axis variable, scale, and line type.

The X Axis tab looks like this for Tide Time Series:

The screenshot shows the 'Plot Data' dialog box with the 'X Axis' tab selected. The 'Variable' dropdown is set to 'Date/Time'. The 'Plot Style' has 'Overlay' selected. The 'Label axis with variable name' checkbox is checked. The 'Line type' is 'Thin Solid', 'Line Color' is green, and 'Line symbol' is 'Solid Circle'. The 'Auto range' checkbox is unchecked, while 'Auto divisions' is checked. The 'Minimum' and 'Maximum' values are set to '01 Jan 2005 00:00:01' and '31 Jan 2005 00:00:01' respectively. The 'Major' and 'Minor' divisions are set to 4 and 1. The 'Start Process', 'Exit', and 'Cancel' buttons are at the bottom.

Callout boxes:

- Top right:** Date and time only available selection for X axis if a .tid file was selected on File Setup tab
- Middle right:**
 - *Overlay* – overlay plot for all Y axis variables on one plot, or
 - *Stacked* - create a separate plot for each Y axis variable, with plots stacked vertically above each other.
- Left side:** Select to label axis with variable name as listed in drop down Variable list, or enter a Custom label for axis.
- Bottom left:**
 - *Auto range* - Plot Data selects axis Minimum and Maximum values, number of Major divisions on axis, and number of Minor divisions between Major divisions.
 - *Auto divisions* - Plot Data selects number of major divisions on axis, and number of minor divisions between major divisions. User selects axis Minimum and Maximum values. Any values that fall outside user-selected Minimum to Maximum range will plot at minimum or maximum, as applicable.
- Bottom center:** Click **Start Process** to begin processing data. Status field shows *Processing complete* when done.
- Bottom right:**
 - Return to Seasoft for Waves window.
 - If *Confirm Program Setup Change* was selected in Options menu - If you made changes and did not Save or Save As, program asks if you want to save changes.
 - If *Confirm Program Setup Change* was not selected in Options menu - This button says **Save & Exit**. If you do not want to save changes, use Cancel button to exit.
- Bottom right (near Exit):** Select desired line type, color, and symbol. Selection of color or monochrome plot, and inclusion of symbols in plot, is made on Plot Setup tab, and applies to all axes.

Y Axis Tab

The Y Axis tabs define the Y axis variables, scales, and line types.

Include this axis in plot. Plot Data can plot 1 X and up to 4 Y axes. At least 1X and 1 Y variable is required, so this selection is available only on Y Axis 2, 3, and 4. Note: If you deselect an axis, all axes numbered above that axis are automatically deselected.

Select to label axis with variable name as listed in drop down Variable list, or enter a Custom label for axis.

- **Auto range** - Plot Data selects axis Minimum and Maximum values, number of Major divisions on axis, and number of Minor divisions between Major divisions.
- **Auto divisions** - Plot Data selects number of major divisions on axis, and number of minor divisions between major divisions. User selects axis Minimum and Maximum values.

Any values that fall outside user-selected Minimum to Maximum range plot at minimum or maximum, as applicable.

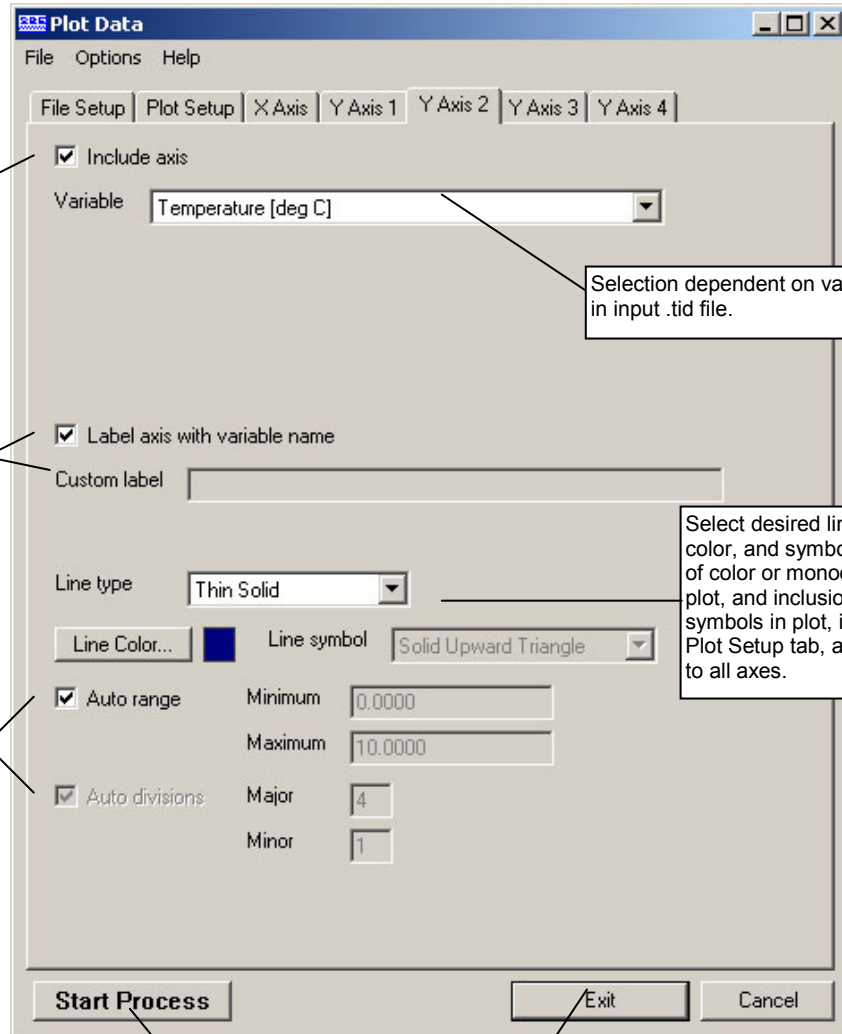

Selection dependent on variables in input .tid file.

Select desired line type, color, and symbol. Selection of color or monochrome plot, and inclusion of symbols in plot, is made on Plot Setup tab, and applies to all axes.

Click **Start Process** to begin processing data. Status field shows *Processing complete* when done.

Return to Seasoft for Waves window.

- If *Confirm Program Setup Change* was selected in Options menu - If you made changes and did not Save or Save As, program asks if you want to save changes.
- If *Confirm Program Setup Change* was not selected in Options menu - This button says **Save & Exit**. If you do not want to save changes, use Cancel button to exit.

Viewing and Outputting Plots

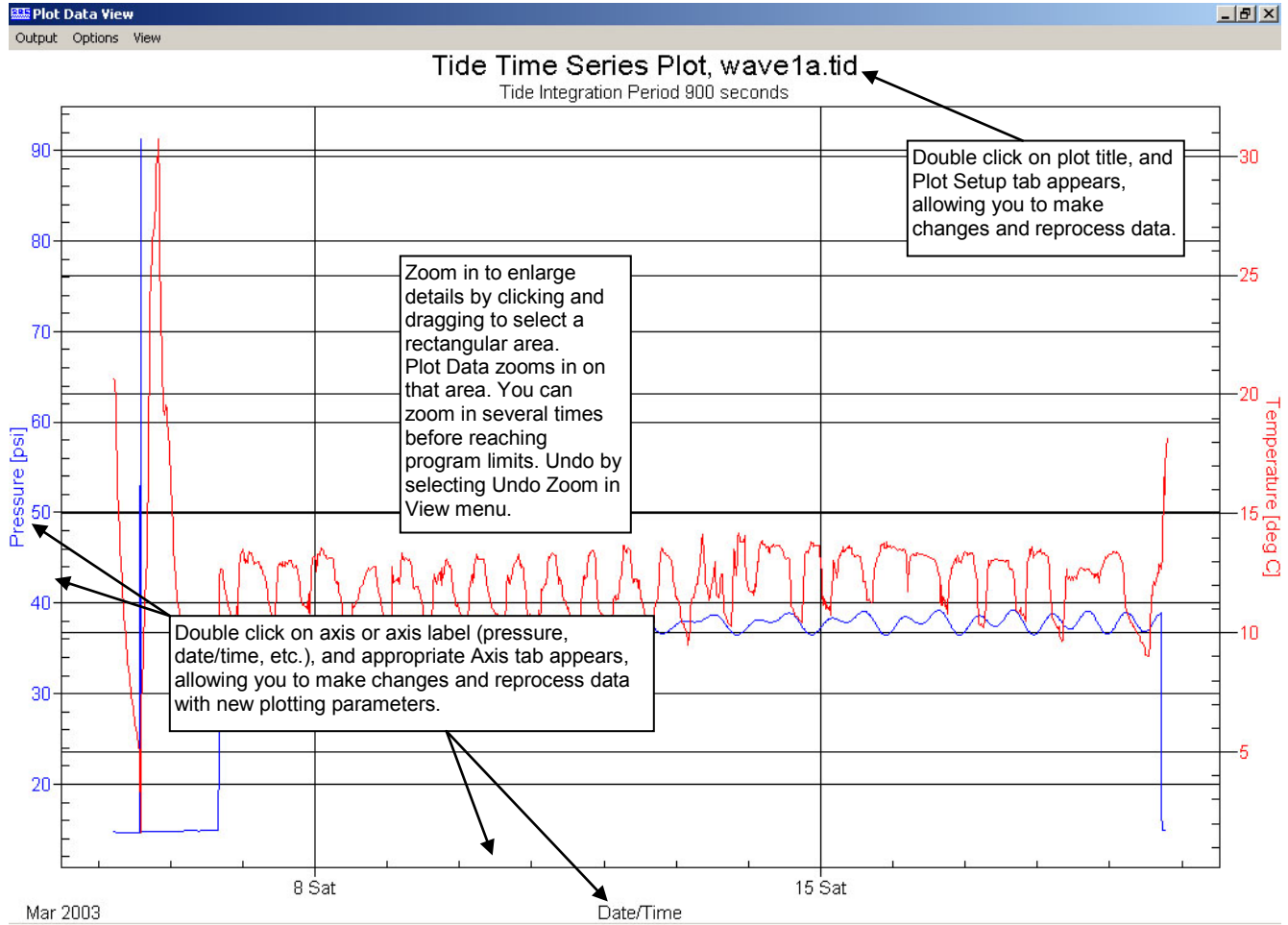

The Plot Data View window's menus are described below:

Output – Output the plot to printer, clipboard, or a file.

- *Print* – Print the single plot that is displayed on screen. In the dialog box, select printer, orientation, color, etc.; these selections override selections you made in Plot Data and in the Plot Data View **Options** menu.
- *File* – Output to file the single plot that is displayed on screen, in the selected format (.wmf, .jpg, or .bmp). In the dialog box, select the desired directory and output file name; these selections override selections you made in Plot Data and in the Plot Data View **Options** menu.
- *Clipboard* – Output to the clipboard the single plot that is displayed on screen, in the selected format (.wmf, .jpg, or .bmp). The selected format overrides the selection you made in the Plot Data View **Options** menu.
- *Print Range* – Not applicable to SBE 53 data.
- *File Range* – Not applicable to SBE 53 data.

Note:

To change the default printer in Windows XP: Click Start / Printers and Faxes. A list of printers installed on your system appears, with a check mark next to the default printer. Right click on the desired printer, and select Set as Default Printer.

Options – Sets up defaults for *how* the plot is output to the printer, file, or clipboard.

- *Print* –
 - Orientation – landscape, portrait, or (printer) driver default. If driver default is selected, orientation is determined by the default for the printer you select in Output / Print (if printing a single plot) or the system default printer (if printing multiple plots using Output / Print Range).
 - Print full page – If selected, scale plot to fit 8 ½ x 11 inch page. If not selected, Size determined by - Plot Data View Dimensions – plot dimensions as shown on screen. Values Entered Below – Units, Width, and Height entered here.
- *File* –
 - Data format – Metafile (.wmf), Jpeg (.jpg), or Bitmap (.bmp).
 - Size determined by - Plot Data View Dimensions – plot dimensions as shown on screen. Values Entered Below – Units, Width, and Height entered here.
- *Clipboard* –
 - Data format – Metafile (.wmf), Jpeg (.jpg), or Bitmap (.bmp).
 - Size determined by - Plot Data View Dimensions – plot dimensions as shown on screen. Values Entered Below – Units, Width, and Height entered here.

View – Sets up viewing options.

- *First Burst, Last Burst, Next Burst, Prior Burst, Go to Burst* – Not applicable to SBE 53 data.
- *Undo Zoom* – Return the plot to the original ranges specified on the Axis tabs. *Undo Zoom* is grayed out unless you have zoomed in (by clicking and dragging to select a rectangular area) to enlarge details.
- *Set Zoomed Ranges* – Substitute the current zoomed ranges of the plot for the Minimum and Maximum plot ranges on the Axis tabs. This allows you to save the ranges of the zoomed view, so you can go to exactly the same view the next time you run Plot Data. *Set Zoomed Ranges* is grayed out unless you have zoomed in (by clicking and dragging to select a rectangular area) to enlarge details.

Section 9: Routine Maintenance and Calibration

This section reviews corrosion precautions, connector mating and maintenance, O-ring maintenance, optional conductivity cell storage and cleaning, battery replacement, pressure sensor maintenance, and sensor calibration. The accuracy of the SBE 53 is sustained by the care and calibration of the sensors and by establishing proper handling practices.

Corrosion Precautions

Rinse the SBE 53 with fresh water after use and prior to storage. All exposed metal is titanium. No corrosion precautions are required, but avoid direct electrical connection of the titanium to dissimilar metal hardware.

The optional SBE 4M conductivity cell has a titanium housing. No corrosion precautions are required, but avoid direct electrical connection of the titanium to dissimilar metal hardware.

Connector Mating and Maintenance

Note:

See *Application Note 57: Connector Care and Cable Installation*.

Clean and inspect connectors, cables, and dummy plugs before every deployment and as part of your yearly equipment maintenance. Inspect connectors that are unmated for signs of corrosion product around the pins, and for cuts, nicks or other flaws that may compromise the seal.

CAUTIONS:

- **Do not use WD-40** or other petroleum-based lubricants, as they will damage the connector.
- For wet-pluggable MCBH connectors: **Silicone lubricants in a spray can** may contain ketones, esters, ethers, alcohols, or glycols in their propellant. **Do not use these sprays, as they will damage the connector.**

When remating:

1. Lightly lubricate the inside of the dummy plug/cable connector with silicone grease (DC-4 or equivalent).
2. **XSG Connector** - Install the plug/cable connector, aligning the raised bump on the side of the plug/cable connector with the large pin (pin 1 - ground) on the SBE 53. Remove any trapped air by *burping* or gently squeezing the plug/connector near the top and moving your fingers toward the end cap. **OR**
MCBH Connector – Install the plug/cable connector, aligning the pins.
3. Place the locking sleeve over the plug/cable connector. Tighten the locking sleeve finger tight only. **Do not overtighten the locking sleeve and do not use a wrench or pliers.**

Verify that a cable or dummy plug is installed for each connector on the system before deployment.

O-Ring Maintenance

Note:

For details on recommended practices for cleaning, handling, lubricating, and installing O-rings, see the *Basic Maintenance of Sea-Bird Equipment* module in the Sea-Bird training materials on our website.

Recommended inspection and replacement schedule:

- For battery end cap O-rings - inspect each time you open the housing to replace the batteries; replace approximately once a year.
- For O-rings that are not normally disturbed (for example, on the connector end cap) – replace approximately every 3 to 5 years.

CAUTION:

Do not use Parker O-Lube, which is petroleum based; use only Super O-Lube.

Remove any water from the O-rings and mating surfaces in the housing with a lint-free cloth or tissue. Inspect O-rings and mating surfaces for dirt, nicks, and cuts. Clean or replace as necessary. Apply a light coat of O-ring lubricant (Parker Super O Lube) to O-rings and mating surfaces.

Conductivity Cell Maintenance

CAUTIONS:

- **Do not put a brush or any object inside the conductivity cell to dry it or clean it.** Touching and bending the electrodes can change the calibration. Large bends and movement of the electrodes can damage the cell.
- **Do not store the SBE 4M with water in the conductivity cell.** Freezing temperatures (for example, in Arctic environments or during air shipment) can break the cell if it is full of water.

The SBE 53's optional conductivity cell (SBE 4M) is shipped dry to prevent freezing in shipping. **Refer to *Application Note 2D: Instructions for Care and Cleaning of Conductivity Cells* for conductivity cell cleaning procedures and cleaning materials.**

- The Active Use (after each cast) section of the application note is not applicable to the SBE 4M, which is intended for use as a moored instrument.

Battery Replacement



Alkaline D-cell
(MN1300, LR20)

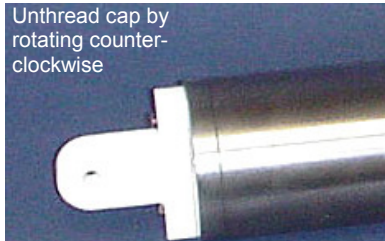

Unthread cap by
rotating counter-
clockwise

Note: photo shows instrument with plastic housing; detail for SBE 53 (which has titanium housing) is similar

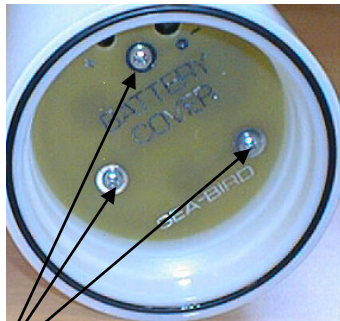

Remove Phillips-head
screws and washers

Note: Alkaline and lithium batteries require different cover plates, because 1 lithium DD cell is shorter than 2 alkaline D cells.



For lithium DD cells

For alkaline D cells

The SBE 53 uses 12 alkaline D-cells (Duracell MN1300, LR20) or 6 lithium DD-cells (Electrochem BCX85-3B76-TC), dropped into the battery compartment.

Leave the batteries in place when storing the SBE 53 to prevent depletion of the back-up lithium batteries by the real-time clock. Even *exhausted* main batteries power the clock (less than 25 microamperes) almost indefinitely. If the SBE 53 is to be stored for long periods, **replace the batteries yearly to prevent battery leakage** (which could damage the SBE 53).

1. Remove the battery end cap (end cap without connectors):
 - A. Wipe the outside of the end cap and housing dry, being careful to remove any water at the seam between them.
 - B. Remove the end cap by rotating counter-clockwise (use a wrench on the white plastic bar if necessary).
 - C. Remove any water from the O-ring mating surfaces inside the housing with a lint-free cloth or tissue.
 - D. Put the end cap aside, being careful to protect the O-ring from damage or contamination.
2. Remove the battery cover plate from the housing:
 - A. Remove the three Phillips-head screws and washers from the battery cover plate inside the housing.
 - B. The battery cover plate will pop out. Put it aside.
3. Turn the SBE 53 over and remove the batteries.
4. Install the new batteries, with the + terminals against the flat battery contacts and the - terminals against the spring contacts.
5. Reinstall the battery cover plate in the housing:
 - A. Align the battery cover plate with the housing. The posts inside the housing are not placed symmetrically, so the cover plate fits into the housing only one way. Looking at the cover plate, note that one screw hole is closer to the edge than the others, corresponding to the post that is closest to the housing.
 - B. Reinstall the three Phillips-head screws and washers, while pushing hard on the battery cover plate to depress the spring contacts at the bottom of the battery compartment. **The screws must be fully tightened, or battery power to the circuitry will be intermittent.**
6. Check the battery voltage at BAT + and BAT - on the battery cover plate. For alkaline batteries, it should be approximately 18 volts. For lithium DD cell batteries, it should be approximately 21 volts.
7. Reinstall the battery end cap:
 - A. Remove any water from the O-rings and mating surfaces with a lint-free cloth or tissue. Inspect the O-rings and mating surfaces for dirt, nicks, and cuts. Clean or replace as necessary. Apply a light coat of o-ring lubricant (Parker Super O Lube) to O-rings and mating surfaces.
 - B. Carefully fit the end cap into the housing and screw the end cap into place. Use a wrench on the white plastic bar to ensure the end cap is tightly secured.

CAUTION:
Do not use Parker O-Lube, which is petroleum based; use only Super O-Lube.

Pressure Sensor Maintenance

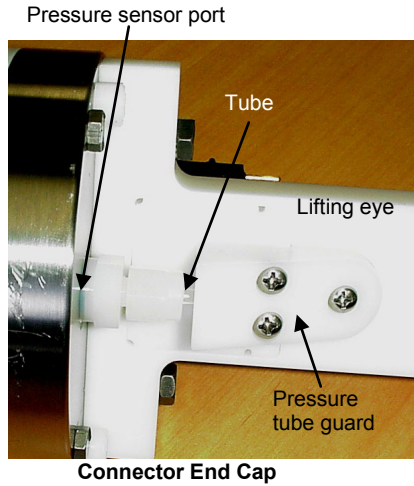

The pressure fitting – which includes a pressure port fitting, external tube, and polyurethane bladder bag – is filled with silicone oil at the factory. The oil transmits hydrostatic pressure via internal, capillary tubing to the pressure sensor inside the instrument, and prevents corrosion that might occur if the sensor diaphragm was exposed to water. The bladder bag is vacuum back-filled.

The bladder bag can develop tears and leaks over time. If the fitting has been damaged, or investigation due to poor data shows that the bag has torn, replace the fitting and bag and refill the oil. **Sea-Bird highly recommends that you send the SBE 53 back to the factory for this repair, as it is difficult to completely remove all air from the system in the field, resulting in potential pressure errors.** However, if you must do the repair to meet a deployment schedule, contact Sea-Bird to purchase the needed parts.

Parts required:

Part Number	Description	Quantity
30551	Pressure port bladder bag	2 *
50025	Pressure sensor oil refill kit (provided with SBE 53 shipment) **	1
50029	Nylon capillary assembly	2 *
30002	Swagelock, nylon, NY-200-1-OR	2 *
30521	Syringe, 60 cc, DURR #899069, MFG #309663 (18 gage needle ground)	1

* Only 1 is required, but we recommend that you purchase a spare in case you have difficulty with the procedure.

** If you have a bell jar, use it to de-gas the oil in the oil refill kit.

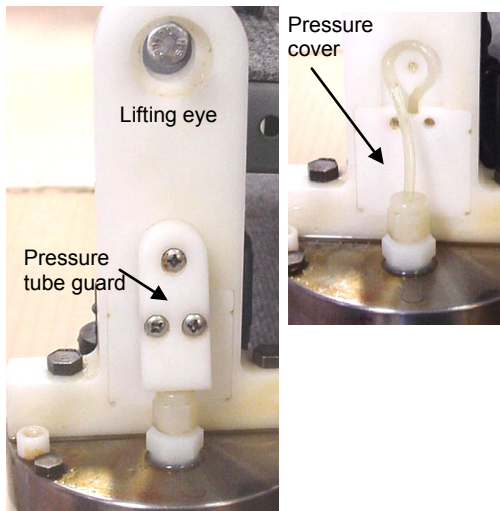

1. Securely mount the SBE 53 vertically (connector end cap up).
2. Remove the 3 Phillips-head screws attaching the pressure tube guard to the lifting eye. Remove the pressure tube guard and the pressure cover that is under it.

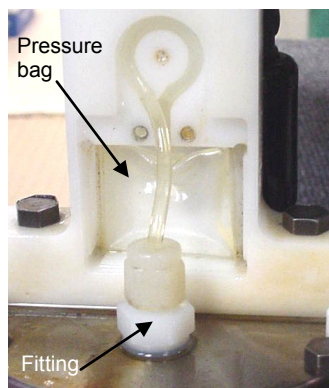

3. Remove the fitting from the end cap with a 9/16 inch wrench. Discard the fitting, tubing, and pressure bag.

CAUTION:
Do not put a brush or any object in the pressure port. Doing so may damage or break the pressure sensor.

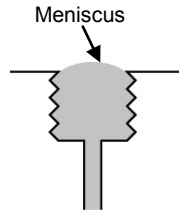
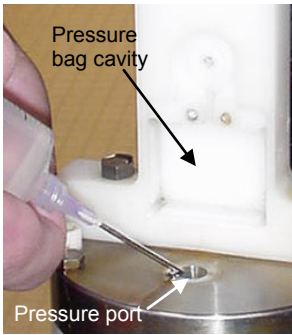

4. Clean the pressure bag cavity in the lift eye and the removed pressure tube guard and pressure cover, removing all residue/grit. Ensure that the holes in each corner of the pressure bag cavity in the lift eye are free of obstructions.
5. Clean the sensor end cap, being careful to remove any residue/grit near the pressure port.
6. From the 50025 pressure sensor oil refill kit, fill the small syringe with the supplied oil. Fill the pressure port, forming a meniscus on the surface of the end cap. Keep the SBE 53 in the vertical position for at least 30 minutes before proceeding, to allow any bubbles in the internal plumbing to rise to the surface. Add oil from the small syringe as necessary to maintain the meniscus.

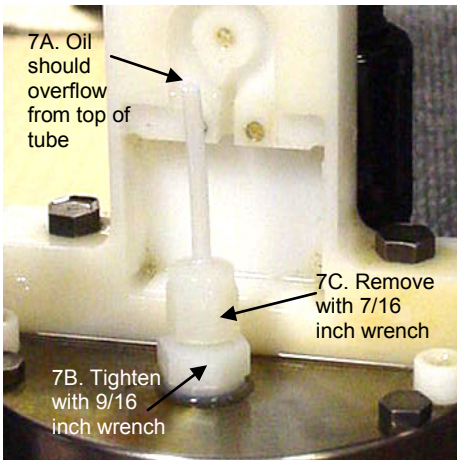

7. Install the supplied capillary fitting (50029) in the pressure port.
 - A. As the fitting is installed, oil should rise the length of the tube and overflow. Wipe up the excess oil with a paper towel.
 - B. Gently tighten the lower portion of the fitting with a 9/16 inch wrench - **DO NOT OVERTIGHTEN**.
 - C. Remove the upper portion of the capillary fitting and tube using a 7/16 inch wrench. Store it for possible use another time.
8. Using the small syringe, add oil to the lower portion of the fitting, forming a meniscus.

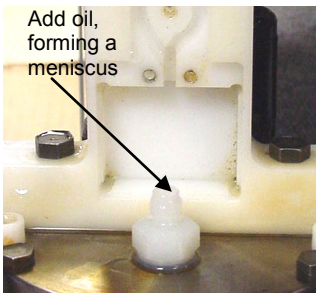

9. Fill the large syringe (30521) 1/4 full with oil.

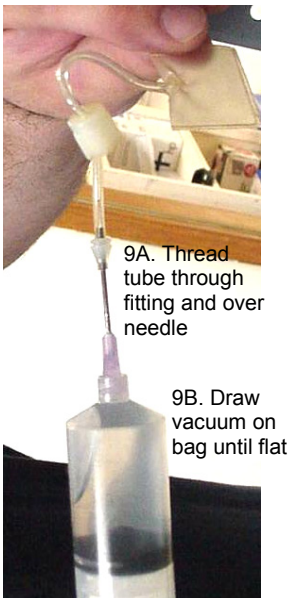

- A. Thread the tube from the pressure bag (30551) through the Swagelock fitting (30002), and install the pressure bag tube over the needle.
- B. Pull the plunger back on the syringe, drawing a vacuum on the pressure bag until it is completely flat. Maintain the vacuum on the bag.
- C. Hold the syringe vertically with the bag down and slowly release the plunger, allowing the vacuum to be released. The bag should slowly fill with oil. There is enough oil in the bag when the bag looks like a *small pillow*. It is very important that there are no air bubbles in the pressure bag; you may have to perform this step several times to ensure that there are no bubbles.

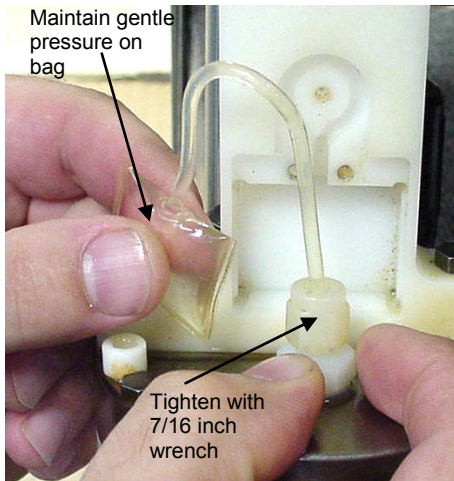

10. After the bag is filled, gently remove the tube from the needle, keeping the bag at or below the level of the end of the tube to prevent air from entering the bag. Maintaining gentle pressure on the bag to keep the oil at the end of the tube and prevent air from entering the bag, insert the end of the tube into the lower portion of the fitting on the end cap and screw the Swagelok fitting down, using a 7/16 inch wrench. Oil should overflow from the fitting, preventing air from entering the bag; the overflow should stop when the fitting is tightened. When completed, the bag should be approximately 1/2 full of oil and contain no air.

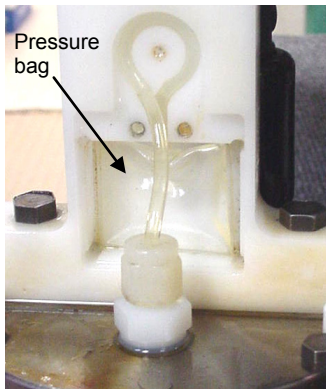

11. Install the pressure bag in the pressure bag cavity. Place the tubing in the indent, going counter-clockwise from the bag to the fitting.

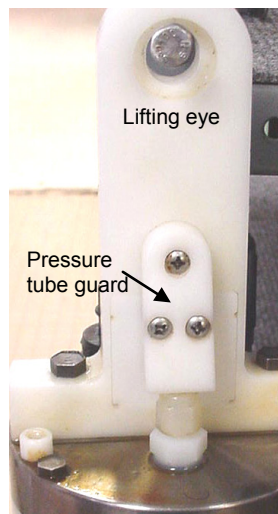
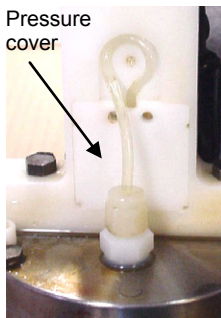

12. Reinstall the pressure cover, pressure tube guard, and 3 Phillips-head screws, being careful not to pinch the tubing or the bag.

13. Log data on the SBE 53, and download the data. Compare the pressure readings to a local barometer. A pinched or overfilled bag will give pressure readings that are higher than the correct values.

Sensor Calibration

Note:

After recalibration of the pressure, temperature, and/or optional conductivity sensor, Sea-Bird enters the new calibration coefficients in the SBE 53 EEPROM, and ships the instrument back to the user with Calibration Certificates showing the new coefficients.

Sea-Bird sensors are calibrated by subjecting them to known physical conditions and measuring the sensor responses. Coefficients are then computed, which may be used with appropriate algorithms to obtain engineering units. The pressure, temperature, and optional conductivity sensors on the SBE 53 are supplied fully calibrated, with coefficients printed on their respective Calibration Certificates (in manual).

We recommend that the SBE 53 be returned to Sea-Bird for calibration.

Pressure Sensor Calibration

The pressure sensor is capable of meeting the SBE 53 error specification with some allowance for aging and ambient-temperature induced drift.

The pressure sensor coefficients are entered into the SBE 53 EEPROM with the calibration coefficient commands. The coefficients can be viewed using **DC** in SeatermW. Values for slope (default = 1.0) and offset (default = 0.0) can be entered in Convert Hex's Coefficient Configuration dialog box to make small post-deployment corrections for sensor drift. Note that the offset entered in Convert Hex is *in addition to* the offset entered in the SBE 53 EEPROM. Techniques are provided below for making small corrections using the slope and offset terms by comparing SBE 53 pressure output to:

- Readings from a barometer
- Readings from a dead-weight pressure generator – provides more accurate results, but requires equipment that may not be readily available

Before using either of these procedures, allow the SBE 53 to equilibrate (with power on) in a reasonably constant temperature environment for at least 5 hours before starting. Pressure sensors exhibit a transient change in their output in response to changes in their environmental temperature. Sea-Bird instruments are constructed to minimize this by thermally decoupling the sensor from the body of the instrument. However, there is still some residual effect; allowing the SBE 53 to equilibrate before starting will provide the most accurate calibration correction.

Calculating Offset using a Barometer

1. Place the SBE 53 in the orientation it will have when deployed.
2. In SeatermW, connect to the SBE 53.
3. Send **FR** to display the pressure and pressure sensor temperature compensation frequencies. Click Stop to end the test. Compute pressure in psia from the frequencies with the formula shown on the calibration sheet.
4. Compare the SBE 53 output to the reading from a good barometer. Calculate *Offset* = barometer reading – SBE 53 reading.
5. Enter the calculated offset (positive or negative) in Convert Hex's Coefficients Configuration dialog box.

Offset Correction Example

Pressure measured by barometer is 1010.50 mbar. Pressure calculated from SBE 53 pressure frequency is 14.06 psia.

Convert barometer reading to psia using relationship: $\text{mbar} * 0.01 \text{ dbar/mbar} * 1 \text{ psia} / 0.689476 \text{ dbar} = \text{psia}$

Barometer reading = 1010.50 mbar * 0.01 / 0.689476 = 14.66 psia *Offset* = 14.66 – 14.06 = +0.60 psia

Enter offset in Convert Hex's Coefficient Configuration dialog box.

Calculating Slope and Offset using a Dead-Weight Pressure Generator

Tests show that room-temperature-derived *slope* and *offset* corrections to the initial quartz calibration can account for long-term drift to within less than 0.01% of the sensor's full scale range. To perform this correction:

1. Use a suitable dead-weight pressure generator to subject the sensor to increments of known pressures. The end cap's $\frac{5}{16}$ -24 straight thread permits mechanical connection to a pressure source. Use a fitting that has an o-ring face seal, such as Swagelok-200-1-OR. See *Application Note 12-1: Pressure Port Oil Refill Procedure & Nylon Capillary Fitting Replacement*.
2. In SeatermW, connect to the SBE 53.
3. Send **FR** to display the pressure and pressure sensor temperature compensation frequencies. Click Stop to end the test. Compute pressure in psia from the frequencies with the formula shown on the calibration sheet.
4. Enter the calculated slope and offset (positive or negative) in Convert Hex's Coefficient Configuration dialog box.

Pressure Slope and Offset Correction Example

A 2000 psia sensor has drifted and its responses are low, as shown below:

Actual Pressure (psia)	Indicated Pressure (psia)
0	-2.533
400	397.3
800	797.2
1200	1197
1600	1597
2000	1996

Linear regression (best straight-line fit) $p_{corrected} = (p_{indicated} * slope) + offset$

yields $slope = +1.000603$ and $offset = +2.405$. Enter these correction coefficients, originally set to 1.0 and 0.0 respectively, in Convert Hex's Coefficient Configuration dialog box.

Temperature Sensor Calibration

The primary source of temperature sensor calibration drift is the aging of the thermistor element. Sensor drift is usually a few thousandths of a degree during the first year, and less in subsequent intervals. Sensor drift is not substantially dependent upon the environmental conditions of use, and — unlike platinum or copper elements — the thermistor is insensitive to shock.

Note:
Temperature sensor calibration coefficients in Convert Hex's Coefficient Configuration dialog box are ignored (software will be updated in future to eliminate these entries from dialog box).

The temperature sensor coefficients are entered into the SBE 53 EEPROM with the calibration coefficient commands. The coefficients can be viewed using **DC** in SeatermW.

Conductivity Sensor Calibration

The optional SBE 4M conductivity sensor incorporates a fixed precision resistor in parallel with the cell. When the cell is dry and in air, the sensor's electrical circuitry outputs a frequency representative of the fixed resistor. This frequency is recorded on the Calibration Certificate and should remain stable (within 1 Hz) over time.

The conductivity sensor calibration certificate shows the following coefficients: g, h, i, j, Cpcor, and Ctcor. View and/or modify these coefficients in Convert Hex's Coefficient Configuration dialog box and in the SBE 53 EEPROM.

- Cpcor makes a correction for the highly consistent change in dimensions of the conductivity cell under pressure. The default is the compressibility coefficient for borosilicate glass (-9.57×10^{-8}). Some sensors fabricated between 1992 and 1995 (serial numbers between 1100 and 1500) exhibit a compression that is slightly less than pure borosilicate glass. For these sensors, the (hermetic) epoxy jacket on the glass cell is unintentionally strong, creating a composite pressure effect of borosilicate and epoxy. For sensors tested to date, this composite pressure coefficient ranges from -9.57×10^{-8} to -6.90×10^{-8} , with the latter value producing a correction to deep ocean salinity of 0.0057 PSU in 5000 dbars pressure (approximately 0.001 PSU per 1000 dbars). Before modifying Cpcor, confirm that the sensor behaves differently from pure borosilicate glass. Sea-Bird can test your cell and calculate Cpcor. Alternatively, test the cell by comparing computed salinity to the salinity of water samples from a range of depths, calculated using an AutoSal.

Enter the value for slope (default = 1.0) in the SBE 53 EEPROM to make small corrections for conductivity sensor drift between calibrations:

Corrected conductivity = (slope * computed conductivity)

where

slope = true conductivity span / instrument conductivity span

Note:

See Application Note 31 for computation of slope correction coefficient from pre- and post-cruise calibrations supplied by Sea-Bird or from salinity bottle samples taken at sea during profiling.

Conductivity Slope and Offset Correction Example

At true conductivity = 3.5 S/m, instrument reading = 3.49965 S/m

Calculating the slope:

Slope = $3.5 / 3.49965 = +1.0001000100010001000100010001$

The primary mechanism for calibration drift in conductivity sensors is the fouling of the cell by chemical or biological deposits. Fouling changes the cell geometry, resulting in a shift in cell constant (slope of the calibration curve), typically resulting in lower conductivity readings over time. Offset error (error at 0 S/m) is usually due to electronics drift, and is typically less than ± 0.0001 S/m per year. Because offsets greater than ± 0.0002 S/m are a symptom of sensor malfunction, Sea-Bird recommends that drift corrections be made by assuming no offset error, unless there is strong evidence to the contrary or a special need.

The most important determinant of long-term sensor accuracy is the cleanliness of the cell. We recommend that the conductivity sensors be calibrated before and after deployment, but particularly when the cell has been exposed to contamination by oil slicks or biological material.

Section 10: Troubleshooting

This section reviews common problems in operating the SBE 53, and provides the most common causes and solutions.

Problem 1: Unable to Communicate with SBE 53

The `S>` prompt indicates that communications between the SBE 53 and computer have been established. Before proceeding with troubleshooting, attempt to establish communications again by clicking Connect in SeatermW or hitting the Enter key several times.

Cause/Solution 1: The I/O cable connection may be loose. Check the cabling between the SBE 53 and computer for a loose connection.

Cause/Solution 2: The instrument, Comm port, and/or baud rate may not have been entered correctly in SeatermW. Select Configure in the Communications menu, and verify the settings. **Note that you need to select the SBE 26*plus* in SeatermW to communicate with the SBE 53;** the SBE 26*plus* and SBE 53 have the same communication settings.

Cause/Solution 3: The I/O cable may not be the correct one. The I/O cable supplied with the SBE 53 permits connection to the DB-9P input connector on an RS-232 interface.

- SBE 53 Pin 1 (large pin on XSG connector) goes to DB-9 pin 5 (ground)
- SBE 53 pin 2 (counter-clockwise from pin 1) goes to DB-9 pin 3
- SBE 53 pin 3 (opposite pin 1) goes to DB-9 pin 2

Cause/Solution 4: In rare cases, the program that controls the SBE 53 microprocessor can be corrupted by a severe static shock or other problem. This program can be initialized by using the reset switch. Proceed as follows to initialize:

1. **As a precaution, upload all data before proceeding.**
2. Open the battery end cap and remove the batteries (see *Replacing Batteries* in *Section 9: Routine Maintenance and Calibration* for details).
3. There is a toggle reset switch on the battery compartment bulkhead, which is visible after the batteries are removed. The switch is used to disconnect the internal back-up lithium batteries from the electronics. Set the switch to the reset position for at least 5 minutes.
4. Reinstall or replace the batteries, and close the battery end cap.
5. Establish communications with the SBE 53 (see *Section 5: SBE 53 Setup, Installation, and Data Upload - SeatermW* for details). Send the status command (**DS**) to verify that the setup is unaffected.

Note:

Using the reset switch does not affect the SBE 53 memory - data in memory and user-programmable parameter values are unaffected.

Problem 2: Nonsense or Unreasonable *Uploaded Data*

The symptom of this problem is an uploaded file that contains unreasonable values (for example, values that are outside the expected range of the data).

Cause/Solution 1: An uploaded data file with unreasonable values for pressure, temperature, or optional conductivity may be caused by incorrect calibration coefficients in either of the following places:

- In the instrument EEPROM - pressure, temperature, and conductivity sensor coefficients. View the coefficients by sending **DC** in SeatermW. If necessary, modify calibration coefficient(s) by sending the appropriate coefficient command(s) (see *Command Descriptions* in *Section 5: SBE 53 Setup, Installation and Data Upload – SeatermW*).
- In the instrument .psa file used by Convert Hex – pressure sensor slope and offset (this offset is in addition to the offset programmed in the instrument EEPROM). View/modify the coefficients by clicking the Coefficients button in Convert Hex’s dialog box.

Verify that the calibration coefficients match the instrument Calibration Certificates.

Problem 3: Nonsense or Unreasonable *Real-Time or Queried Data*

Note:

If real-time or queried **pressure** values are unreasonable, note that a pressure slope and offset can be entered in Convert Hex’s Coefficient Configuration dialog box to make small post-deployment corrections for pressure sensor drift on the uploaded data.

The symptom of this problem is real-time or queried data that contains unreasonable values (for example, values that are outside the expected range of the data).

Cause/Solution 1: Real-time or queried data with unreasonable values for pressure, temperature, or optional conductivity and salinity may be caused by incorrect pressure, temperature, and conductivity calibration coefficients in the instrument EEPROM. View the coefficients by sending **DC** in SeatermW; verify that the calibration coefficients match the instrument Calibration Certificates. If necessary, modify calibration coefficient(s) by sending the appropriate coefficient command(s) (see *Command Descriptions* in *Section 5: SBE 53 Setup, Installation and Data Upload – SeatermW*).

Glossary

Battery and Memory Endurance – Seasoftware for Waves module for calculating power endurance and memory endurance for a user-specified sampling scheme.

Convert Hex – Seasoftware for Waves module for converting uploaded .hex file into tide (.tid) and reference frequency (.ref) files.

Fouling – Biological growth in the conductivity cell during deployment.

Merge Barometric Pressure – Seasoftware for Waves module for removing barometric pressure from tide data.

PCB – Printed Circuit Board.

Plot Data – Seasoftware for Waves module for plotting tide data.

Seasoftware for Waves - DOS – Modular DOS program for use with the SBE 26. **Seasoftware for Waves -DOS is not compatible with the SBE 53.**

Seasoftware for Waves – Modular Win 95/98/NT/2000/XP program for pre-deployment planning, communication with the SBE 53 for setup, uploading of data from the SBE 53, separation of uploaded data into separate wave and tide files, removal of barometric pressure from tide data, statistical analysis, and data plotting. Modules applicable to SBE 53 include Battery and Memory Endurance, SeatermW, Convert Hex, Merge Barometric Pressure, and Plot Data.

SeatermW – Seasoftware for Waves module for communication with the SBE 53 for setup and uploading of data from the SBE 53.

CAUTION:
Do not use Parker O-Lube, which is petroleum based; use only Super O-Lube.

Super O-Lube – Silicone lubricant used to lubricate O-rings and O-ring mating surfaces. Super O-Lube can be ordered from Sea-Bird, but should also be available locally from distributors. Super O-Lube is manufactured by Parker Hannifin (www.parker.com/ead/cm2.asp?cmid=3956).

TCXO – Temperature Compensated Crystal Oscillator.

Triton X-100 – Reagent grade non-ionic surfactant (detergent), used for cleaning the conductivity cell. Triton can be ordered from Sea-Bird, but should also be available locally from chemical supply or laboratory products companies. Triton is manufactured by Mallinckrodt Baker (see www.mallinckrodt.com/changecountry.asp?back=/Default.asp for local distributors).

Appendix I: Command Summary

Note:

See *Command Descriptions* in Section 5: *SBE 53 Setup, Installation, and Data Upload - SeatermW* for detailed information and examples.

CATEGORY	COMMAND	DESCRIPTION
Setup	Status	DS Display status and setup parameters.
	SetTime	Set real-time clock date and time.
	DateTime=x	x = real-time clock date and time. See <i>Setting Time in SBE 53 to Synchronize Sampling of Multiple Instruments</i> in Section 5.
	Baud=x	x = baud rate for general communication (600, 1200, 2400, 4800, 9600, 19200, or 38400). Default 9600.
	External Temperature=	x=Y : External thermistor. x=N : Internal thermistor. Default.
	Conductivity=x	x=Y : Enable conductivity logging (if optional conductivity sensor included). x=N : Do not.
	UserInfo=x	x = user-defined string (displays in DS reply).
	TxTide=x	x=Y : Transmit real-time tide data. x=N : Do not.
	QS	Enter quiescent (sleep) state. Main power turned off, memory retention unaffected.
Tide Setup	SetSampling (or SetSample)	Set sampling parameters: <ul style="list-style-type: none"> Continuously power pressure sensor? If no, pressure sensor warm-up (minimum 5 minutes, recommended 15 minutes). Tide interval (1 – 60 minutes). Tide duration (1 – 60 minutes). Reference frequency interval (corresponding to no more than 1/day and no less than 1/month) At receipt of Start, start logging at SetStartTime or immediately? Stop logging at SetStopTime or wait for user to send Stop?
Initialize Logging (Reset Memory)	InitLogging	After all data uploaded , send this before starting to sample to make entire memory available for recording. If not sent, data stored after last sample.
	TideCount=x	x = tide sample number for first tide measurement when sampling begins. Use to recover data if you accidentally initialize logging before ASCII uploading.
	*ByteCount=x	x = byte number for first byte when sampling begins. Use to recover data if you accidentally initialize logging before binary uploading.
Logging	Start	Start logging now (if <i>use start time?</i> in SetSampling prompt is <i>No</i>), or Start waiting to start logging (if <i>use start time?</i> in SetSampling is <i>Yes</i>).
	Stop	Stop logging now.
	SetStartTime	Set date and time to start logging. At receipt of Start , SBE 53 starts logging at this date and time if <i>Use start time?</i> in SetSampling is <i>Yes</i> .
	SetStopTime	Set date and time to stop logging. SBE 53 stops logging at this date and time if <i>Use stop time?</i> in SetSampling is <i>Yes</i> .
Send Last Sample	SL	Send data from last tide measurement and do not go to sleep (do not enter quiescent state).
	SLO	Send data from last tide measurement and go to sleep (enter quiescent state).
Data Upload	DD	Upload data in ASCII at baud set for general communication with Baud= .
	DBbaud,b,e	Upload data in binary at baud (1200, 2400, 4800, 9600, 19200, 28800, 38400, 57600, or 115200) from byte b to e . First byte is 0. Can upload up to 500,000 bytes at one time.
	ByteCount	Display total number of bytes in memory.

Note:

Use the Upload menu to upload data that will be processed by Seasoft for Waves. Manually entering a data upload command does not produce data in the required format for processing by Seasoft for Waves.

CATEGORY	COMMAND	DESCRIPTION
Diagnostic (data from these tests not stored in FLASH memory)	TS	Take 1 sample of pressure, pressure temperature, temperature, and conductivity, and output converted data.
	TSR	Take 1 sample of pressure, pressure temperature, temperature, and conductivity, and output raw data.
	TT	Sample temperature, and output converted data. SBE 53 runs continuously, drawing current. Press Esc key or click Stop to stop test.
	TTR	Sample temperature, and output raw data. SBE 53 runs continuously, drawing current. Press Esc key or click Stop to stop test.
	FR	Measure and output conductivity frequency. SBE 53 runs continuously, drawing current. Press Esc key or click Stop to stop test.
	VR	Measure and output: <ul style="list-style-type: none"> • main battery voltage / 11.18 • back-up lithium battery voltage / 4.8187 • operating current (mA) / 20.04 • ground voltage SBE 53 runs continuously, drawing current. Press Esc key or click Stop to stop test.
	*FlashInit	Map bad blocks and erase FLASH memory, destroying all data.
	*FlashGood	Display number of good blocks in FLASH memory.
Calibration Coefficients (F=floating point number; S=string with no spaces) Dates shown are when calibrations were performed. Coefficients are initially factory-set and should agree with Calibration Certificates shipped with SBE 53.	DC	Display sensor calibration coefficients.
	PCalDate=S	S=pressure calibration date.
	PU0=F	F=pressure U0.
	PY1=F	F=pressure Y1.
	PY2=F	F=pressure Y2.
	PY3=F	F=pressure Y3.
	PC1=F	F=pressure C1.
	PC2=F	F=pressure C2.
	PC3=F	F=pressure C3.
	PD1=F	F=pressure D1.
	PD2=F	F=pressure D2.
	PT1=F	F=pressure T1.
	PT2=F	F=pressure T2.
	PT3=F	F=pressure T3.
	PT4=F	F=pressure T4.
	POffset=F	F=pressure offset (psia).
	FRA0=F	F=reference frequency A0.
	FRA1=F	F=reference frequency A1.
	FRA2=F	F=reference frequency A2.
	FRA3=F	F=reference frequency A3.
	TCalDate=S	S=temperature calibration date.
	TA0=F	F=temperature A0.
	TA1=F	F=temperature A1.
	TA2=F	F=temperature A2.
	TA3=F	F=temperature A3.
	CCalDate=S	S=conductivity calibration date.
CG=F	F=conductivity G.	
CH=F	F=conductivity H.	
CI=F	F=conductivity I.	
CJ=F	F=conductivity J.	
CTCor=F	F=conductivity TCOR.	
CPCor=F	F=conductivity PCOR.	
CSlope=F	F=conductivity slope correction.	

Appendix II: Sample Timing

Notes

- When **Start** is sent:
 - If *Use start time?* in the **SetSampling** prompt is *No*, the SBE 53 starts logging 10 seconds after receipt of **Start**.
 - If *Use start time?* in the **SetSampling** prompt is *Yes*, the SBE 53 starts logging at **SetStartTime**.
- If *Use start time?* in the **SetSampling** prompt is *Yes*, and **SetStartTime** is less than 10 seconds in the future when **Start** is sent, the SBE 53 ignores the programmed start time and starts logging in 10 seconds.
- If *Use stop time?* in the **SetSampling** prompt is *Yes*, and **SetStopTime** is less than 1 hour after logging begins, the SBE 53 ignores the programmed stop time and continues logging until **Stop** is sent.
- The SBE 53 integrates the pressure sensor output over the entire tide duration, calculating and storing an average pressure for that time period. The SBE 53 measures the temperature (T) and optional conductivity (C) associated with the tide *after* the tide duration. The time stamp (the time reported with the tide pressure, temperature, and conductivity data) is the time at the **beginning** of the tide duration.
- The SBE 53 requires 5 minutes for each reference frequency measurement. The measurement timing is dependent on whether the pressure sensor and reference frequency oscillator are continuously powered:
 - **Continuously powered -**
 - If (tide interval – tide duration) \geq 10 minutes, reference frequency measurement is done **after** the applicable tide measurement.
 - If (tide interval – tide duration) $<$ 10 minutes **and** tide duration \geq 10 minutes, reference frequency measurement is done **during** the applicable tide measurement.
 - If (tide interval – tide duration) $<$ 10 minutes **and** tide duration $<$ 10 minutes, reference frequency measurement is **disabled**.
 - **Not continuously powered (user-programmable warmup time) -**
 - If (tide interval – tide duration - warmup) \geq 10 minutes, reference frequency measurement is done **after** the applicable tide measurement.
 - If (tide interval – tide duration - warmup) $<$ 10 minutes **and** tide duration \geq 10 minutes, reference frequency measurement is done **during** the applicable tide measurement.
 - If (tide interval – tide duration - warmup) $<$ 10 minutes **and** tide duration $<$ 10 minutes **and** warmup \geq 10 minutes, reference frequency measurement is done **during** the applicable reference frequency measurement.
 - If (tide interval – tide duration - warmup) $<$ 10 minutes **and** tide duration $<$ 10 minutes **and** warmup $<$ 10 minutes, reference frequency measurement is **disabled**.

Sample Timing Schematics

Pressure Sensor and Reference Frequency Oscillator Continuously Powered

- If tide duration > (tide interval – 10 sec), tide duration is set to tide interval and the SBE 53 samples tides continuously.
When tide interval = tide duration, if tide duration ≥ 10 minutes, reference frequency measurement is done during the applicable tide measurement; if tide duration < 10 minutes, reference frequency measurement is disabled.

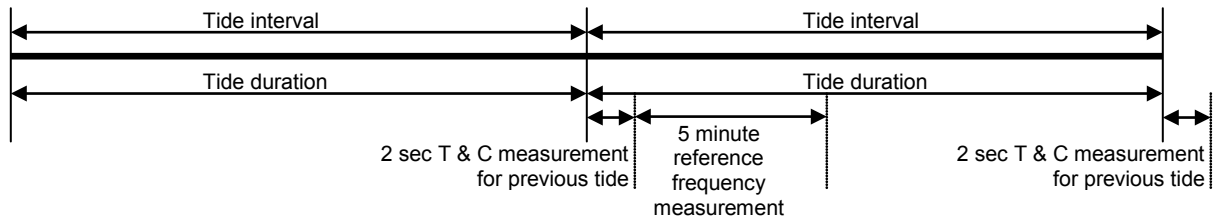

Example 1: Tide interval = tide duration = 15 minutes.
Measure reference frequency every 96 tide measurements (1/day).
Set **SetStartTime** to 12:00:00.
Checking setup: Tide duration = 15 minutes ≥ 10 minutes, so reference frequency measurement is not disabled.

Day & Time	Time Stamp for Tide #	Begin P for Tide #	End P for Tide #	Begin T & C for Tide #	End T & C for Tide #	Begin Reference Frequency Measurement #	End Reference Frequency Measurement #
Day 1 12:00:00	#1	#1	-	-	-	-	-
Day 1 12:15:00	#2	#2	#1	#1	-	-	-
Day 1 12:15:02	-	-	-	-	#1	-	-
Day 1 12:30:00	#3	#3	#2	#2	-	-	-
Day 1 12:30:02	-	-	-	-	#2	-	-
Etc.							
Day 2 12:00:00	#97	#97	#96	#96	-	-	-
Day 2 12:00:02	-	-	-	-	#96	#1	-
Day 2 12:05:02	-	-	-	-	-	-	#1
Day 2 12:15:00	#98	#98	#97	#97	-	-	-
Day 2 12:15:02	-	-	-	-	#97	-	-
Day 2 12:30:00	#99	#99	#98	#98	-	-	-
Day 2 12:30:02	-	-	-	-	#98	-	-
Etc.							

- If tide duration < (tide interval – 10 sec), SBE 53 does not sample tides continuously. There are two cases for timing of the reference frequency.

Case A: If (tide interval – tide duration) ≥ 10 minutes, reference frequency measurement is done **after** the applicable tide measurement.

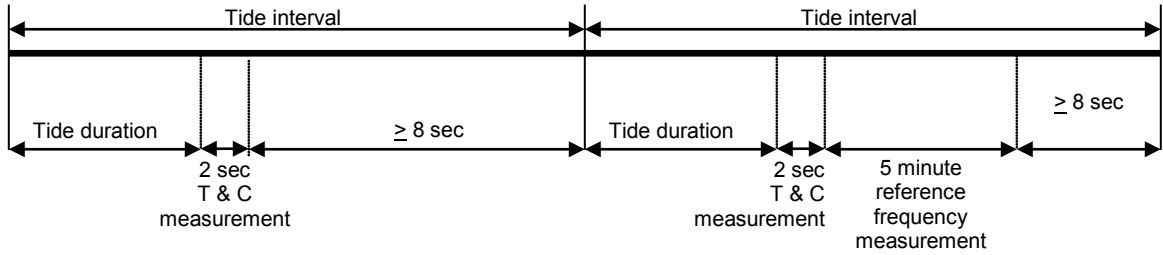

Example 2: Tide interval = 15 minutes; tide duration = 5 minutes.

Set **SetStartTime** to 12:00:00.

Measure reference frequency every 96 tide measurements (1/day).

Checking setup:

tide duration = 5 minutes = 300 sec < tide interval – 10 sec = 15 minutes – 10 sec = 890 sec.

tide interval – tide duration = 15 minutes – 5 minutes = 10 minutes ≥ 10 minutes, so reference frequency measurement is done after the applicable tide measurement.

Day & Time	Time Stamp for Tide #	Begin P for Tide #	End P for Tide #	Begin T & C for Tide #	End T & C for Tide #	Begin Reference Frequency Measurement #	End Reference Frequency Measurement #
Day 1 12:00:00	#1	#1	-	-	-	-	-
Day 1 12:05:00	-	-	#1	#1	-	-	-
Day 1 12:05:02	-	-	-	-	#1	-	-
Day 1 12:15:00	#2	#2	-	-	-	-	-
Day 1 12:20:00	-	-	#2	#2	-	-	-
Day 1 12:20:02	-	-	-	-	#2	-	-
Etc.							
Day 2 12:00:00	#97	#97	-	-	-	-	-
Day 2 12:05:00	-	-	#97	#97	-	-	-
Day 2 12:05:02	-	-	-	-	#97	#1	-
Day 2 12:10:02	-	-	-	-	-	-	#1
Day 2 12:15:00	#98	#98	-	-	-	-	-
Day 2 12:20:00	-	-	#98	#98	-	-	-
Day 2 12:20:02	-	-	-	-	#98	-	-
Etc.							

Case B: If (tide interval – tide duration) < 10 minutes **and** tide duration ≥ 10 minutes, reference frequency measurement is done **during** the applicable tide measurement; if tide duration < 10 minutes, reference frequency measurement is disabled.

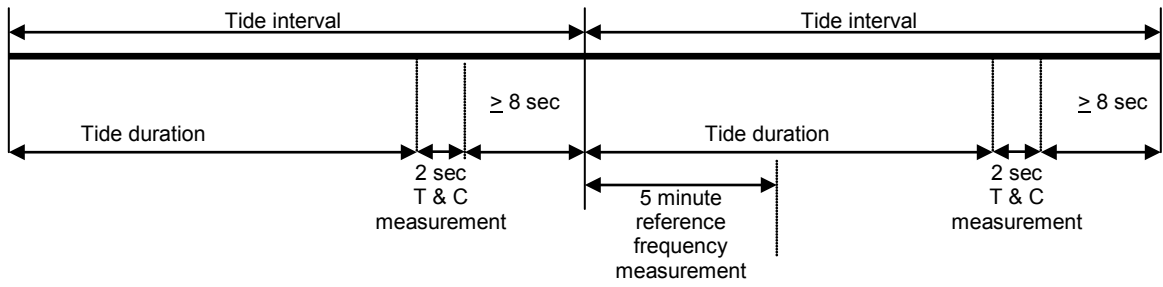

Example 3: Tide interval = 15 minutes; tide duration = 12 minutes.

Set **SetStartTime** to 12:00:00.

Measure reference frequency every 96 tide measurements (1/day).

Checking setup:

tide duration = 12 minutes = 720 sec < tide interval – 10 sec = 15 minutes – 10 sec = 890 sec.

tide interval – tide duration = 15 minutes – 12 minutes = 3 minutes < 10 minutes, so reference frequency measurement is done during the applicable tide measurement (tide duration = 12 minutes ≥ 10 minutes, so reference frequency measurement is not disabled).

Day & Time	Time Stamp for Tide #	Begin P for Tide #	End P for Tide #	Begin T & C for Tide #	End T & C for Tide #	Begin Reference Frequency Measurement #	End Reference Frequency Measurement #
Day 1 12:00:00	#1	#1	-	-	-	-	-
Day 1 12:12:00	-	-	#1	#1	-	-	-
Day 1 12:12:02	-	-	-	-	#1	-	-
Day 1 12:15:00	#2	#2	-	-	-	-	-
Day 1 12:27:00	-	-	#2	#2	-	-	-
Day 1 12:27:02	-	-	-	-	#2	-	-
Etc.							
Day 2 12:00:00	#97	#97	-	-	-	#1	-
Day 2 12:05:00	-	-	-	-	-	-	#1
Day 2 12:12:00	-	-	#97	#97	-	-	-
Day 2 12:12:02	-	-	-	-	#97	-	-
Day 2 12:15:00	#98	#98	-	-	-	-	-
Day 2 12:27:00	-	-	#98	#98	-	-	-
Day 2 12:27:02	-	-	-	-	#98	-	-
Etc.							

Pressure Sensor and Reference Frequency Oscillator Not Continuously Powered

- If (tide interval – tide duration - warmup) ≥ 10 minutes, reference frequency measurement is done **after** the applicable tide measurement.

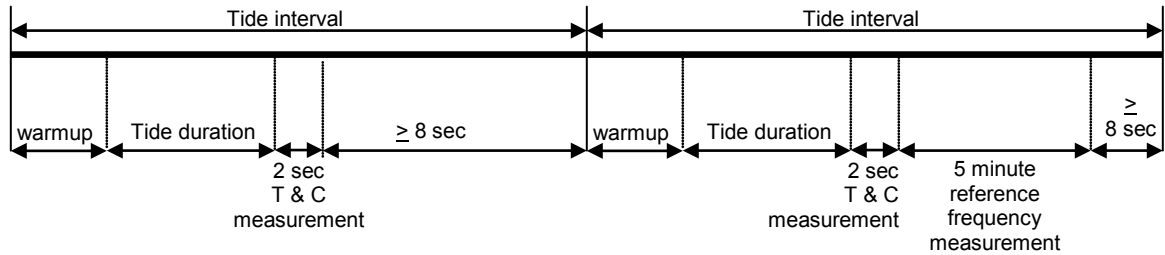

Example 1: Tide interval = 30 minutes; tide duration = 5 minutes; warmup = 15 minutes.

Set **SetStartTime** to 12:00:00.

Measure reference frequency every 48 tide measurements (1/day).

Checking setup:

tide interval – tide duration – warmup = 30 minutes – 5 minutes – 15 minutes = 10 minutes ≥ 10 minutes, so reference frequency measurement is done after the applicable tide measurement.

Day & Time	Begin Warmup for Tide #	Time Stamp for Tide #	Begin P for Tide #	End P for Tide #	Begin T & C for Tide #	End T & C for Tide #	Begin Reference Frequency Measurement #	End Reference Frequency Measurement #
Day 1 12:00:00	#1	-	-	-	-	-	-	-
Day 1 12:15:00	-	#1	#1	-	-	-	-	-
Day 1 12:20:00	-	-	-	#1	#1	-	-	-
Day 1 12:20:02	-	-	-	-	-	#1	-	-
Day 1 12:30:00	#2	-	-	-	-	-	-	-
Day 1 12:45:00	-	#2	#2	-	-	-	-	-
Day 1 12:50:00	-	-	-	#2	#2	-	-	-
Day 1 12:50:02	-	-	-	-	-	#2	-	-
Etc.								
Day 2 12:00:00	#49	-	-	-	-	-	-	-
Day 2 12:15:00	-	#49	#49	-	-	-	-	-
Day 2 12:20:00	-	-	-	#49	#49	-	-	-
Day 2 12:20:02	-	-	-	-	-	#49	#1	-
Day 2 12:25:02	-	-	-	-	-	-	-	#1
Day 2 12:30:00	#50	-	-	-	-	-	-	-
Day 2 12:45:00	-	#50	#50	-	-	-	-	-
Day 2 12:50:00	-	-	-	#50	#50	-	-	-
Day 2 12:50:02	-	-	-	-	-	#50	-	-
Etc.								

- If (tide interval – tide duration - warmup) < 10 minutes **and** tide duration ≥ 10 minutes, reference frequency measurement is done **during** the applicable tide measurement.

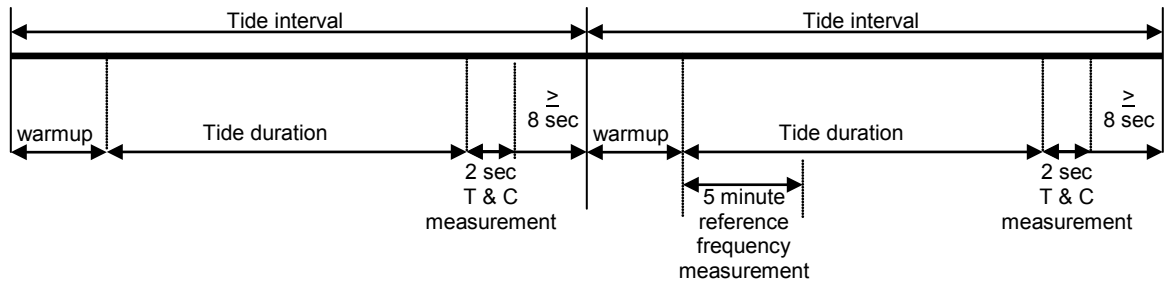

Example 2: Tide interval = 30 minutes; tide duration = 10 minutes; warmup = 15 minutes.

Set **SetStartTime** to 12:00:00.

Measure reference frequency every 48 tide measurements (1/day).

Checking setup:

tide interval – tide duration – warmup = 30 minutes – 10 minutes – 15 minutes = 5 minutes < 10 minutes, **and**

tide duration = 10 minutes ≥ 10 minutes, so reference frequency measurement is done during the applicable tide measurement.

Day & Time	Begin Warmup for Tide #	Time Stamp for Tide #	Begin P for Tide #	End P for Tide #	Begin T & C for Tide #	End T & C for Tide #	Begin Reference Frequency Measurement #	End Reference Frequency Measurement #
Day 1 12:00:00	#1	-	-	-	-	-	-	-
Day 1 12:15:00	-	#1	#1	-	-	-	-	-
Day 1 12:25:00	-	-	-	#1	#1	-	-	-
Day 1 12:25:02	-	-	-	-	-	#1	-	-
Day 1 12:30:00	#2	-	-	-	-	-	-	-
Day 1 12:45:00	-	#2	#2	-	-	-	-	-
Day 1 12:55:00	-	-	-	#2	#2	-	-	-
Day 1 12:55:02	-	-	-	-	-	#2	-	-
Etc.								
Day 2 12:00:00	#49	-	-	-	-	-	-	-
Day 2 12:15:00	-	#49	#49	-	-	-	#1	-
Day 2 12:20:00	-	-	-	-	-	-	-	#1
Day 2 12:25:00	-	-	-	#49	#49	-	-	-
Day 2 12:25:02	-	-	-	-	-	#49	-	-
Day 2 12:30:00	#50	-	-	-	-	-	-	-
Day 2 12:45:00	-	#50	#50	-	-	-	-	-
Day 2 12:55:00	-	-	-	#50	#50	-	-	-
Day 2 12:55:02	-	-	-	-	-	#50	-	-
Etc.								

- If (tide interval – tide duration - warmup) < 10 minutes **and** tide duration < 10 minutes **and** warmup ≥ 10 minutes, reference frequency measurement is done **during** the applicable warmup; if warmup < 10 minutes, reference frequency measurement is disabled.

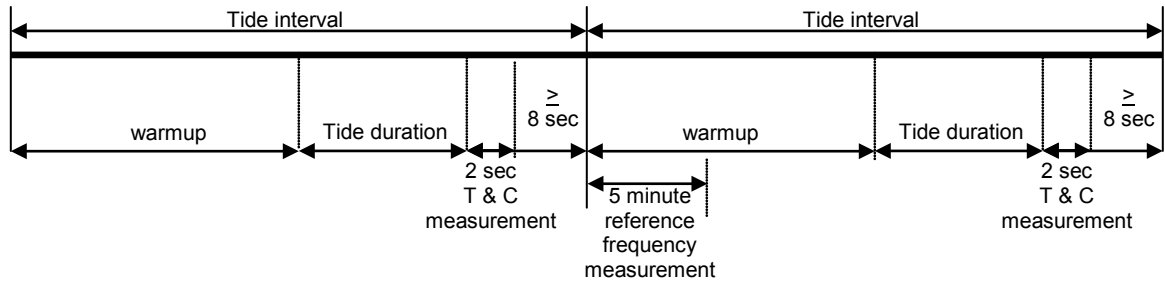

Example 3: Tide interval = 30 minutes; tide duration = 8 minutes; warmup = 15 minutes.

Set **SetStartTime** to 12:00:00.

Measure reference frequency every 48 tide measurements (1/day).

Checking setup:

tide interval – tide duration – warmup = 30 minutes – 8 minutes – 15 minutes = 7 minutes < 10 minutes, **and** tide duration = 8 minutes < 10 minutes, **and**

warmup = 15 minutes ≥ 10 minutes, so reference frequency measurement is done during the applicable warmup (warmup = 15 minutes ≥ 10 minutes, so reference frequency measurement is not disabled).

Day & Time	Begin Warmup for Tide #	Time Stamp for Tide #	Begin P for Tide #	End P for Tide #	Begin T & C for Tide #	End T & C for Tide #	Begin Reference Frequency Measurement #	End Reference Frequency Measurement #
Day 1 12:00:00	#1	-	-	-	-	-	-	-
Day 1 12:15:00	-	#1	#1	-	-	-	-	-
Day 1 12:23:00	-	-	-	#1	#1	-	-	-
Day 1 12:23:02	-	-	-	-	-	#1	-	-
Day 1 12:30:00	#2	-	-	-	-	-	-	-
Day 1 12:45:00	-	#2	#2	-	-	-	-	-
Day 1 12:53:00	-	-	-	#2	#2	-	-	-
Day 1 12:53:02	-	-	-	-	-	#2	-	-
Etc.								
Day 2 12:00:00	#49	-	-	-	-	-	#1	-
Day 2 12:05:00	-	-	-	-	-	-	-	#1
Day 2 12:15:00	-	#49	#49	-	-	-	-	-
Day 2 12:23:00	-	-	-	#49	#49	-	-	-
Day 2 12:23:02	-	-	-	-	-	#49	-	-
Day 2 12:30:00	#50	-	-	-	-	-	-	-
Day 2 12:45:00	-	#50	#50	-	-	-	-	-
Day 2 12:53:00	-	-	-	#50	#50	-	-	-
Day 2 12:53:02	-	-	-	-	-	#50	-	-
Etc.								

Appendix III: Data Formats

This appendix provides detailed information on data format for each file type, except as noted.

Extension	Description
.cap	Capture file of queried data (response to SL or SLO), or capture file of real-time data from SBE 53 (output if TxTide=Y).
.hex	Hex data uploaded from SBE 53 memory using SeatermW.
.tid	Tide data, created from .hex file by Convert Hex. Also, file output by Merge Barometric Pressure, which removes barometric pressure from an input .tid file.
.ref	Reference frequency data, created from .hex file by Convert Hex. Can be used in post-processing to adjust .tid data for pressure sensor drift.
.bp	Barometric pressure data, used by Merge Barometric Pressure to remove barometric pressure from tide data (.tid) file. See <i>Section 7: Tide Data Processing – Merge Barometric Pressure</i> for .bp format.

Queried Data Format (.cap extension)

Queried data is obtained by sending **SL** or **SLO** (command the SBE 53 to send the last sample from memory) while logging. Queried data is saved to a .cap file if you click Capture in SeatermW. Each time **SL** or **SLO** is sent, the display looks like this:

```
pr = 14.5266, pc= 14.5266, t = 22.7003, s = 29.05335,
06 Jul 2005 08:30:00
```

where:

- pr = stored raw pressure, converted to psia.
- pc = corrected pressure (not stored) converted to psia, with correction based on most recent measured reference frequency.
- t = stored temperature, converted to °C.
- s = calculated salinity (computed from stored temperature and conductivity) in psu. Displays only if **DS** response shows `conductivity = YES` (conductivity acquisition was enabled with **Conductivity=Y**).
- Date/time is the date/time stored in memory with the data.

Note:

See *Making Corrections Using Reference Frequency Data* below for pressure correction algorithm.

Real-Time Data Format (.cap extension)

Real-time data is output if the **DS** response shows `transmit real-time tide data = YES` (real-time tide data was enabled with **TxTide=Y**). Real-time output is saved to a .cap file if you click Capture in SeatermW.

Each time a tide measurement is completed, the display looks like this:

```
Tide: start time = 06 Jul 2005 13:40:01, pr =14.2135,
pc = 14.2135, pt = 21.352, t = 21.0250, c = 4.81952, s = 34.3799
```

where:

- start time = start of tide measurement.
- pr = stored raw pressure, converted to psia.
- pc = corrected pressure (not stored) converted to psia, with correction based on most recent measured reference frequency.
- pt = stored pressure temperature, converted to °C.
- t = stored temperature, converted to °C.
- c = stored conductivity, converted to S/m, and s = calculated salinity (not stored) in psu.

Conductivity and salinity display only if **DS** response shows `conductivity = YES` (conductivity acquisition was enabled with **Conductivity=Y**).

Notes:

- Each tide measurement record displays **after** the tide duration is complete. For example, if the tide duration is 10 minutes, the first tide data displays 10 minutes after logging starts.
- See *Making Corrections Using Reference Frequency Data* below for pressure correction algorithm.

Hex Data Format (.hex extension)

A .hex file contains hexadecimal data uploaded from SBE 53 memory using SeatermW's Upload.

The beginning of a sample .hex file **without conductivity** follows:

```
*Sea-Bird SBE 53 BPR Data File
*FileName = H:\sbe53\test-4.hex
*Software Version 1.11
*DS
*SBE 53 BPR V 1.2 SN 12345 26 Oct 2012 15:17:26
*user info=test setup
*quartz pressure sensor: serial number = 90319, range = 10000 psia
*conductivity = NO
*iop = 10.1 ma vmain = 14.8 V vlith = 0.0 V
*last sample: p = 21.9520, t = 21.0250
*
*tide measurement: interval = 15.000 minutes, duration = 15 minutes,
power pressure sensor continuously
*measure reference frequency every 3 tide samples
*logging start time = do not use start time
*logging stop time = do not use stop time
*
*tide samples/day = 96.000
*memory endurance = 15420.2 days
*nominal battery endurance = 67 days alkaline, 207 days lithium
*total recorded tide measurements = 12
*total recorded reference frequency measurements = 4
*tide measurements since last start = 12
*transmit real-time tide data = YES
*
*status = stopped by user
*logging = NO, send start command to begin logging
*S>DC
*Pressure coefficients: 04-15-2003
* U0 = 5.822311e+00
* . . . (more pressure sensor calibration coefficients)
*Temperature coefficients: 24-dec-04
* TA0 = 2.542717e-04
* TA1 = 2.511151e-04
* TA2 = -1.767157e-06
* TA3 = 1.562220e-07
*S>DD
63B4753A18ED1D4E07AE0641E409D6BAB1 (tide data)
63B4753518ED1D4D07AE09429C09D6BE35 (tide data)
63B4753B18ED1D4E07AE0942A609D6C1B9 (tide data)
FFFFFFFF004B004D04775041B809D6C548 (reference frequency scan)
63B4757A18ED1D5E07AE0741E909D6C53D (tide data)
63B4754818ED1D5207AE0642CF09D6C8C1 (tide data)
63B4754818ED1D5207AE0642D909D6CC45 (tide data)
FFFFFFFF004B004D06F75B431309D6CFD4 (reference frequency scan)
. . .
```

Note:

If you uploaded data in binary, SeatermW sent **DBbaud,b,e** instead of **DD**. However, the uploaded .hex file **always** shows the **DD** command, so the file looks exactly the same, regardless of whether ASCII or binary upload was used.

The beginning of a sample .hex file **with conductivity** follows:

(beginning of file, with **DS** and **DC** response, same as above, except **DS** response shows *conductivity* = *YES*, calculated memory endurance and battery endurance in **DS** response is reduced, and **DC** response shows conductivity coefficients in addition to other coefficients)

```
*S>DD
63B4753A18ED1D4E07AE0641E40A415C09D6BAB1 (tide data)
63B4753518ED1D4D07AE09429C0A415409D6BE35 (tide data)
63B4753B18ED1D4E07AE0942A60A415809D6C1B9 (tide data)
FFFFFFFF004B004D04775041B80A415A09D6C548 (reference frequency scan)
63B4757A18ED1D5E07AE0741E90A415309D6C53D (tide data)
63B4754818ED1D5207AE0642CF0A415209D6C8C1 (tide data)
63B4754818ED1D5207AE0642D90A415B09D6CC45 (tide data)
FFFFFFFF004B004D06F75B43130A415109D6CFD4 (reference frequency scan)
. . .
```

Looking at lines in the file(s):

- Beginning lines - * flags header. Header lines contain (in order):
 - Input file name
 - Software version used to upload the data
 - SBE 53 response to status (DS) command
 - SBE 53 response to calibration coefficients (DC) command
- Following lines - Data follows, with each line followed by a carriage return and line feed. Data (lines after the *S>DD) is described below.

Line	SBE 53 <i>without</i> Conductivity (all data is 17 bytes = 34 Hex characters)	SBE 53 <i>with</i> Conductivity (all data is 20 bytes = 40 Hex characters)
1	63B4753A18ED1D4E07AE0641E409D6BAB1 – <ul style="list-style-type: none"> • First 4 bytes (63B4753A) - pressure number. • Next 4 bytes (18ED1D4E) - pressure temperature frequency number. • Next 3 bytes (07AE06) - temperature A/D counts. • Next 2 bytes (41E4) - reference frequency thermistor raw A/D counts. • Last 4 bytes (09D6BAB1) - start time of measurement (seconds since January 1, 2000). 	63B4753A18ED1D4E07AE0641E40A415C09D6BAB1 – <ul style="list-style-type: none"> • First 4 bytes (63B4753A) - pressure number. • Next 4 bytes (18ED1D4E) - pressure temperature frequency number. • Next 3 bytes (07AE06) - temperature A/D counts. • Next 2 bytes (41E4) - reference frequency thermistor raw A/D counts. • Next 3 bytes (0A415C) - conductivity number. • Last 4 bytes (09D6BAB1) - start time of measurement (seconds since January 1, 2000).
2	Same format as line 1	Same format as line 1
3	Same format as line 1	Same format as line 1
4	FFFFFFFF004B004D04775041B809D6C548 – <ul style="list-style-type: none"> • First 4 bytes (FFFFFFFF) - flags this scan as reference frequency scan. Setup for this example was to measure reference frequency every 3 tide samples, so there are 3 tide records before reference frequency scan. • Next 4 bytes (004B004D) - integer part of reference frequency. • Next 3 bytes (047750) - fractional part of reference frequency. • Next 2 bytes (41B8) - reference frequency thermistor raw A/D counts. • Last 4 bytes (09D6C548) - start time of reference frequency scan measurement (seconds since January 1, 2000). 	FFFFFFFF004B004D04775041B80A415A09D6C548 – <ul style="list-style-type: none"> • First 4 bytes (FFFFFFFF) - flags this scan as reference frequency scan. Setup for this example was to measure reference frequency every 3 tide samples, so there are 3 tide records before reference frequency scan. • Next 4 bytes (004B004D) - integer part of reference frequency. • Next 3 bytes (047750) - fractional part of reference frequency. • Next 2 bytes (41B8) - reference frequency thermistor raw A/D counts. • Next 3 bytes (0A415A) - conductivity number. • Last 4 bytes (09D6C548) - start time of reference frequency scan measurement (seconds since January 1, 2000).

Convert Hex converts the hex data and creates two files:

- Output tide (.tid) file - pressure (psia), temperature (°C), (optional) conductivity (S/m) and salinity (psu), and date and time.
- Output reference frequency (.ref) file – reference frequency (Hz), reference frequency thermistor output (Hz), and date and time.

Data conversions are described below:

pressure frequency (Hz) = PF = pressure number / 50000

pressure temperature compensation frequency (Hz) = PTCF

= pressure temperature number / 12500

Pressure is computed as follows:

$$U = [(1.0 / PTCF) * 1000000] - U0$$

$$C = C1 + (C2 * U) + (C3 * U^2)$$

$$D = D1 + D2 \quad \text{but } D2 = 0, \text{ so } D = D1$$

$$T0 = (T1 + T2 * U + T3 * U^2 + T4 * U^3) / 1,000,000$$

$$W = 1.0 - (T0 * T0 * PF * PF)$$

pressure (psia)

= slope correction * [{C * W * (1.0 - D * W)} + POFFSET] + offset correction

where

- U0, C1, C2, C3, D1, T1, T2, T3, T4, and POFFSET are entered in the SBE 53 EEPROM at the factory using the calibration coefficient commands, and are read by Convert Hex from the uploaded .hex file header (in the **DC** command response).
- Slope and offset corrections are read from the Convert Hex calibration coefficients (.psa) file.

temperature (°C) = 1.0 / [TA0 + (r*{TA1 + r*(TA2 + r*TA3)})] - 273.15

where

- r = ln (temperature A/D counts).
- temperature A/D counts is converted from Hex to decimal.
- TA0, TA1, TA2, and TA3 are entered in the SBE 53 EEPROM at the factory using the calibration coefficient commands, and are read by Convert Hex from the uploaded .hex file header (in the **DC** response).

conductivity frequency (Hz) = conductivity number / 256

where

- Conductivity number is converted from Hex to decimal.

Conductivity frequency is converted to conductivity using the coefficients and equation found on the calibration certificate for the sensor. These coefficients are entered in the SBE 53 EEPROM at the factory using the calibration coefficient commands, and are read by Convert Hex from the uploaded .hex file header (in the **DC** response).

time = time number = number of seconds since January 1, 2000

- Time number is converted from Hex to decimal.

Tide Data Format (.tid extension)

A .tid file is created from the .hex file in Convert Hex. A sample tide data (.tid) file is shown below:

1	04/06/05 10:27:16	14.8125	22.102	3.55682	23.909
2	04/06/05 10:28:16	15.0086	14.818	3.48032	27.844
3	04/06/05 10:29:16	15.0836	11.242	3.07901	26.714
4	04/06/05 10:30:16	15.1536	8.951	3.07101	28.376
5	04/06/05 10:31:16	15.2267	7.225	3.06788	29.772

- Column 1 = Tide measurement number
- Columns 2 and 3 = Date and time of beginning of tide measurement
- Column 4 = Raw (uncorrected) pressure (psia)
- Column 5 = Water temperature (°C)
- Column 6 = Conductivity (S/m)
- Column 7 = Calculated salinity (PSU)

Notes:

- If conductivity logging is not enabled (**Conductivity=N**; status display shows `conductivity = NO`), the conductivity and salinity columns are not included in the .tid file.
- See *Making Corrections Using Reference Frequency Data* below for pressure correction algorithm.

If Merge Barometric Pressure has been run on the .tid file to remove the effect of barometric pressure, the output .tid file contains descriptive column headings. The presence of headings in the .tid file indicates that it has been processed by Merge Barometric Pressure. Additionally, Merge Barometric Pressure has the ability to replace the pressure in the fourth column with calculated water depth. See *Section 7: Tide Data Processing – Merge Barometric Pressure* for details, and for the required data format for the barometric pressure (.bp) file to input in Merge Barometric Pressure.

Format with -t Command Line Option

When Convert Hex is run with the `-t` command line option, Convert Hex adds diagnostic information to the .tid file. The .tid file output is:

- Column 1 = Tide measurement number
- Columns 2 and 3 = Date and time of beginning of tide measurement
- Column 4 = Pressure frequency (Hz)
- Column 5 = Pressure temperature frequency (Hz)
- Column 6 = Raw (uncorrected) pressure (psia)
- Column 7 = Water temperature (°C)
- Column 8 = Conductivity (S/m)
- Column 9 = Calculated salinity (PSU)
- Column 10 = Measured thermistor output from reference crystal oscillator (A/D counts)
- Column 11 = Reference crystal oscillator raw temperature (Hz)
- Column 12 = Last reference frequency from reference crystal oscillator (Hz)
- Column 13 = Pressure frequency computed using last measured reference frequency (Hz)
- Column 14 = Pressure temperature frequency computed using last measured reference frequency (Hz)
- Column 15 = Pressure computed using measured reference frequencies (psia)
- Column 16 = Raw (uncorrected) pressure - Pressure computed using measured reference frequencies (psia)

Reference Frequency Data Format (.ref extension)

A .ref file is created from the .hex file in Convert Hex. A sample reference frequency data (.ref) file is shown below:

```

1  04/02/2005 18:15:11 4915277.259918 17120
2  04/03/2005 18:15:11 4915277.292688 17330
3  04/04/2005 18:15:11 4915277.051838 16742
4  04/05/2005 18:15:11 4915276.899446 16532
5  04/06/2005 18:15:11 4915276.833906 16449

```

- Column 1 = Reference frequency measurement number
- Columns 2 and 3 = Date and time of beginning of reference frequency measurement
- Column 4 = Measured reference frequency from crystal oscillator (Hz)
- Column 5 = Measured thermistor output from crystal oscillator (A/D counts)

The reference frequency data can be used to correct the .tid data for long-term drift of the pressure sensor (expected to be on the order of 1 ppm per year).

Sea-Bird does not currently supply software to do this correction.

Making Corrections Using Reference Frequency Data

You can use the reference frequency data in the pressure scans and in the reference frequency scans to correct uploaded data for pressure sensor frequency drift.

$$\text{Reference frequency (Hz)} = \mathbf{Fm} = \text{IRF} + \text{FRF} / 10^6$$

where

- IRF = integer part of reference frequency **in reference frequency scan**
- FRF = fractional part of reference frequency **in reference frequency scan**

$$\mathbf{fc} = \text{FRA0} + (\text{RFT} * \{\text{FRA1} + \text{RFT} * [\text{FRA2} + \text{RFT} * \text{FRA3}]\})$$

where

- RFT = reference frequency thermistor raw A/D counts in **reference frequency scan**
- FRA0, FRA1, FRA2, and FRA3 are entered in the SBE 53 EEPROM at the factory using the calibration coefficient commands

$$\mathbf{offset} = \mathbf{fm} - \mathbf{fc}$$

$$\mathbf{fy} = \text{FRA0} + (\text{RFTP} * \{\text{FRA1} + \text{RFTP} * [\text{FRA2} + \text{RFTP} * \text{FRA3}]\})$$

where

- RFTP = reference frequency thermistor raw A/D counts in **pressure scan**
- FRA0, FRA1, FRA2, and FRA3 are entered in the SBE 53 EEPROM at the factory using the calibration coefficient commands

$$\mathbf{fCor} = \mathbf{fy} + \mathbf{offset}$$

where

offset is a function of time (defined above)

$$\mathbf{corrected\ pressure\ frequency} = \text{recorded pressure frequency} * \mathbf{fCor} / \mathbf{fy}$$

$$\mathbf{corrected\ pressure\ temperature\ frequency} = \text{recorded pressure temperature frequency} * \mathbf{fCor} / \mathbf{fy}$$

Notes:

- When you output real-time data (**TxTide=Y**) or query the SBE 53 with **SL** or **SLO**, it outputs both data that has not been corrected for drift (pr) and data that has been corrected for drift (pc). The SBE 53 uses data from the most recent reference scan in the correction calculation.
- Data uploaded from memory (.hex file) and uploaded data converted to engineering units (.tid file) have not been corrected for drift.

Appendix IV: Electronics Disassembly/Reassembly

Jackscrew kit



Sea-Bird provides a jackscrew kit with the SBE 53, to assist in removal of the connector end cap. The kit contains:

- 2 Allen wrenches
- 3 jackscrews
- 2 spare plastic socket hex-head screws

Disassembly

CAUTION:

Disconnect and dismantle the optional SBE 4M conductivity cell from the SBE 53 before disassembly to avoid breaking the conductivity cell.

1. Establish communications with the SBE 53 (see *Section 5: SBE 53 Setup, Installation, and Data Upload - SeatermW* for details). **As a precaution, click Upload to upload any data in memory before beginning.**
2. Wipe the outside of the end cap and housing dry, being careful to remove any water at the seam between them.
3. Remove the four titanium hex-head screws securing the connector end cap to the housing.
4. Remove the three plastic hex-head screws from the end cap using the larger Allen wrench. Insert the three jackscrews in these three holes in the end cap. When you begin to feel resistance, use the smaller Allen wrench to continue turning the screws. Turn each screw 1/2 turn at a time. As you turn the jackscrews, the end cap will push away from the housing. When the end cap is loosened, pull it and the PCB assembly out of the housing.
5. Remove any water from the O-ring mating surfaces inside the housing with a lint-free cloth or tissue. Be careful to protect the O-rings from damage or contamination.
6. Disconnect the Molex connector connecting the PCB assembly to the battery compartment bulkhead.
7. Remove the jackscrews from the end cap.

Plastic hex-head screw
(typical, 3 places)

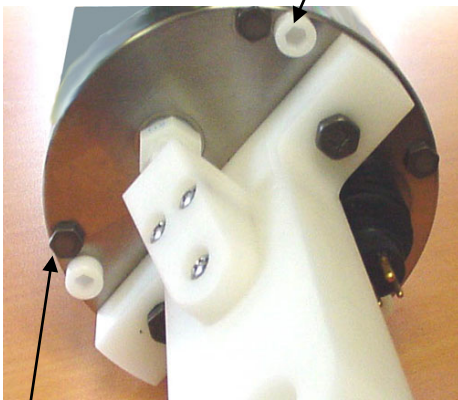

Titanium hex-head screw
(typical, 4 places)

Reassembly

Note:

Before delivery, a desiccant package is inserted in the housing and the electronics chamber is filled with dry Argon gas. These measures help prevent condensation. To ensure proper functioning:

1. Install a new desiccant bag each time you open the electronics chamber. If a new bag is not available, see *Application Note 71: Desiccant Use and Regeneration (drying)*.
2. If possible, dry gas backfill each time you open the housing. If you cannot, wait at least 24 hours before redeploying, to allow the desiccant to remove any moisture from the housing.

Note that opening the battery compartment does not affect desiccation of the electronics.

1. Remove any water from the O-ring and mating surfaces with a lint-free cloth or tissue. Inspect the O-ring and mating surfaces for dirt, nicks, and cuts. Clean or replace as necessary. Apply a light coat of O-ring lubricant (Parker Super O Lube) to O-ring and mating surfaces.
2. Reconnect the Molex connector to the PCB assembly. Verify the connector holds and pins are properly aligned.
3. Carefully fit the PCB assembly into the housing, aligning the holes in the end cap and housing.
4. Reinstall the 4 hex-head screws to secure the end cap to the housing.
5. Reinstall the 3 plastic hex head screws in the end cap.
6. Establish communications with the SBE 53 (see *Section 5: SBE 53 Setup, Installation, and Data Upload - SeatermW* for details). Reset the date and time (**SetTime**) and initialize logging (**InitLogging**) before redeploying. No other parameters should have been affected by electronics disassembly (send **DS** to verify).

CAUTION:

Do not use Parker O-Lube, which is petroleum based; use only Super O-Lube.

Appendix V: AF24173 Anti-Foulant Device

AF24173 Anti-Foulant Devices supplied for user replacement are supplied in polyethylene bags displaying the following label:

AF24173 ANTI-FOULANT DEVICE

FOR USE ONLY IN SEA-BIRD ELECTRONICS' CONDUCTIVITY SENSORS TO CONTROL THE GROWTH OF AQUATIC ORGANISMS WITHIN ELECTRONIC CONDUCTIVITY SENSORS.

ACTIVE INGREDIENT:

Bis(tributyltin) oxide.....	53.0%
OTHER INGREDIENTS:	<u>47.0%</u>
Total.....	100.0%

DANGER

See the complete label within the Conductivity Instrument Manual for Additional Precautionary Statements and Information on the Handling, Storage, and Disposal of this Product.

Net Contents: Two anti-foulant devices

Sea-Bird Electronics, Inc.
1808 - 136th Place Northeast
Bellevue, WA 98005

EPA Registration No. 74489-1
EPA Establishment No. 74489-WA-1

AF24173 Anti-Foulant Device

FOR USE ONLY IN SEA-BIRD ELECTRONICS' CONDUCTIVITY SENSORS TO CONTROL THE GROWTH OF AQUATIC ORGANISMS WITHIN ELECTRONIC CONDUCTIVITY SENSORS.

ACTIVE INGREDIENT:

Bis(tributyltin) oxide.....	53.0%
OTHER INGREDIENTS:	47.0%
Total.....	100.0%

DANGER

See Precautionary Statements for additional information.

FIRST AID	
If on skin or clothing	<ul style="list-style-type: none"> • Take off contaminated clothing. • Rinse skin immediately with plenty of water for 15-20 minutes. • Call a poison control center or doctor for treatment advice.
If swallowed	<ul style="list-style-type: none"> • Call poison control center or doctor immediately for treatment advice. • Have person drink several glasses of water. • Do not induce vomiting. • Do not give anything by mouth to an unconscious person.
If in eyes	<ul style="list-style-type: none"> • Hold eye open and rinse slowly and gently with water for 15-20 minutes. • Remove contact lenses, if present, after the first 5 minutes, then continue rinsing eye. • Call a poison control center or doctor for treatment advice.
HOT LINE NUMBER	
Note to Physician	Probable mucosal damage may contraindicate the use of gastric lavage.
Have the product container or label with you when calling a poison control center or doctor, or going for treatment. For further information call National Pesticide Telecommunications Network (NPTN) at 1-800-858-7378.	

Net Contents: Two anti-foulant devices

Sea-Bird Electronics, Inc.
 1808 - 136th Place Northeast
 Bellevue, WA 98005

EPA Registration No. 74489-1
 EPA Establishment No. 74489-WA-1

PRECAUTIONARY STATEMENTS

HAZARD TO HUMANS AND DOMESTIC ANIMALS

DANGER

Corrosive - Causes irreversible eye damage and skin burns. Harmful if swallowed. Harmful if absorbed through the skin or inhaled. Prolonged or frequently repeated contact may cause allergic reactions in some individuals. Wash thoroughly with soap and water after handling.

PERSONAL PROTECTIVE EQUIPMENT

USER SAFETY RECOMMENDATIONS

Users should:

- Remove clothing immediately if pesticide gets inside. Then wash thoroughly and put on clean clothing.
- Wear protective gloves (rubber or latex), goggles or other eye protection, and clothing to minimize contact.
- Follow manufacturer's instructions for cleaning and maintaining PPE. If no such instructions for washables, use detergent and hot water. Keep and wash PPE separately from other laundry.
 - Wash hands with soap and water before eating, drinking, chewing gum, using tobacco or using the toilet.

ENVIRONMENTAL HAZARDS

Do not discharge effluent containing this product into lakes, streams, ponds, estuaries, oceans, or other waters unless in accordance with the requirements of a National Pollutant Discharge Elimination System (NPDES) permit and the permitting authority has been notified in writing prior to discharge. Do not discharge effluent containing this product to sewer systems without previously notifying the local sewage treatment plant authority. For guidance contact your State Water Board or Regional Office of EPA. This material is toxic to fish. Do not contaminate water when cleaning equipment or disposing of equipment washwaters.

PHYSICAL OR CHEMICAL HAZARDS

Do not use or store near heat or open flame. Avoid contact with acids and oxidizers.

DIRECTIONS FOR USE

It is a violation of Federal Law to use this product in a manner inconsistent with its labeling. For use only in Sea-Bird Electronics' conductivity sensors. Read installation instructions in the applicable Conductivity Instrument Manual.

STORAGE AND DISPOSAL

PESTICIDE STORAGE: Store in original container in a cool, dry place. Prevent exposure to heat or flame. Do not store near acids or oxidizers. Keep container tightly closed.

PESTICIDE SPILL PROCEDURE: In case of a spill, absorb spills with absorbent material. Put saturated absorbent material to a labeled container for treatment or disposal.

PESTICIDE DISPOSAL: Pesticide that cannot be used according to label instructions must be disposed of according to Federal or approved State procedures under Subtitle C of the Resource Conservation and Recovery Act.

CONTAINER DISPOSAL: Dispose of in a sanitary landfill or by other approved State and Local procedures.

Appendix VI: Pressure-to-Depth Conversion

Force is mass * acceleration, units are Newtons [N]:

$$N = \text{Kg m} / \text{sec}^2$$

Density (ρ) is mass / volume, units are [Kg / m^3]:

This is the *in situ* value, and is approximately $1025 \text{ Kg} / \text{m}^3$ at the surface.

Specific weight (W) is weight / volume, units are [N / m^3]:

$$W = \rho * g$$

where g = local gravity [m / sec^2]

Hydrostatic equation:

$$p = p_{\text{atm}} + W * z$$

p_{atm} = atmospheric pressure in Pascals [N / m^2]

p = total pressure in Pascals [N / m^2]

W is average density times gravity [N / m^3]

z = depth [m]

Conversions:

$$1 \text{ Pascal} = 10^{-4} \text{ decibars}$$

$$1 \text{ psi} = 0.6894757 \text{ decibars}$$

Example:

$$\text{average density} = 1025 \text{ kg} / \text{m}^3$$

$$\text{average gravity} = 9.8 \text{ m} / \text{sec}^2$$

$$\text{pressure reading} = 6000 \text{ decibars} = 6 \times 10^7 \text{ Pascals}$$

$$\text{atmospheric pressure} = 14.7 \text{ psia} = 1.013529 \times 10^5 \text{ Pascals}$$

$$W = 1025 * 9.8 = 10045 \text{ [N} / \text{m}^3]$$

$$6 \times 10^7 - 1.013529 \times 10^5 = 10045 * z$$

$$z = 5.989865 \times 10^7 / 10045 = 5963.031 \text{ meters}$$

Appendix VII: Replacement Parts

Part Number	Part	Application Description	Quantity in 53
22018	Alkaline D-cell batteries, Duracell MN1300 (LR20)	Power 53	12
41124B	Battery cover plate	Retains alkaline D-cell batteries	1
801575	Battery cover plate/spacer	Retains lithium DD-cell batteries with buttons	-
30346	Screw, 10-24 x 1" hex-head, titanium	Secures connector end cap to housing	4
50092	SBE 16/19 Jackscrew Kit	For removing connector end cap	1
60021	Spare battery end cap hardware and o-rings	O-rings and hardware, including: <ul style="list-style-type: none"> • 30145 Screw, 6-32 x 1/2" Phillips-head, stainless steel (secures battery cover plate to battery posts) • 30242 Washer, #6 flat, stainless steel (for screw 30145) • 30816 Parker 2-234E603-70 (battery end cap to housing piston seal) • 30090 Parker 2-153N674-70 (battery end cap to housing face seal) 	-
50056	Spare parts kit	Assorted hardware and o-rings, including: <ul style="list-style-type: none"> • 30145 Screw, 6-32 x 1/2" Phillips-head, stainless steel (secures battery cover plate to battery posts) • 30242 Washer, #6 flat, stainless steel (for screw 30145) • 30447 Bolt 1/4-20 x 1 1/4 Hex, titanium (secures lift eye to connector end cap and plastic bar to battery end cap) • 30816 Parker 2-234E603-70 (battery end cap to housing piston seal) • 30090 Parker 2-153N674-70 (battery end cap to housing face seal) • 30815 Parker 2-233E603-70 (connector end cap to housing radial piston seal) 	-

Continued on next page

Continued from previous page

Part Number	Part	Application Description	Quantity in 53
17695	3-pin RMG-3FS to 3-pin RMG-3FS cable, 0.28 m (11 in.) long	From SBE 53 to optional conductivity sensor	1
171752	3-pin to MCIL-3FS (wet-pluggable connector) to 3-pin RMG-3FS cable, 0.28 m (11 in.) long	From SBE 53 to optional conductivity sensor	1
801225	4-pin RMG-4FS to DB-9S data I/O cable, 2.4 m (8 ft) long	From SBE 53 to computer	1
801374	4-pin MCIL-4FS (wet-pluggable connector) to DB-9S data I/O cable, 2.4 m (8 ft) long	From SBE 53 to computer	1
171888	25-pin DB-25S to 9-pin DB-9P cable adapter	For use with computer with DB-25 connector	-
17043	Locking sleeve	Locks I/O cable or dummy plug in place	2
171192	Locking sleeve (wet-pluggable connector)	Locks I/O cable or dummy plug in place	2
17045.1	3-pin RMG-3FS dummy plug with locking sleeve	For when optional conductivity sensor not used	1
171500.1	3-pin MCDC-3-F (wet-pluggable) dummy plug with locking sleeve	For when optional conductivity sensor not used	1
17046.1	4-pin RMG-4FS dummy plug with locking sleeve	For I/O connector during deployment	1
171398.1	4-pin MCDC-4-F (wet-pluggable) dummy plug with locking sleeve	For I/O connector during deployment	1
801542	AF24173 Anti-Foulant Device	For use with optional conductivity sensor – Bis(tributyltin) oxide device inserted into anti-foulant device cup in mount kit	1 (set of 2)
50315	Anti-foulant device mount kit	Mounts on ends of conductivity cell to hold AF24173 Anti-Foulant Devices	1
30411	Triton X-100	Octyl Phenol Ethoxylate – Reagent grade non-ionic cleaning solution for conductivity cell (supplied in 100% strength; dilute as directed)	1

Appendix X: Manual Revision History

Manual Version	Date	Description
001	04/05	<ul style="list-style-type: none"> • First release of SBE 53.
002	07/05	<ul style="list-style-type: none"> • Firmware version 1.1a -- DS output now includes battery endurance. • Seasoft for Waves 1.11 – Battery and Memory Endurance module now can do calculations for SBE 53. • Add lithium DD battery capacity information. • Eliminate discussion of battery spacers for lithium DD batteries, different cover plate works with shorter batteries. Show both alkaline and lithium cover plate. • Correct external power to 12-24 VDC instead of 12-20 VDC. • Update power specs (small changes). • Update connector information for wet-pluggables; now using water block version. • Remove 80290 alkaline drop-in battery pack, not offered for SBE 53. • Remove mounting fixture, not offered for SBE 53. • Add pressure sensor maintenance section.
003	02/06	<ul style="list-style-type: none"> • Firmware version 6.1a – add DateTime= (sent using DateTime menu in SeatermW). • Seasoft for Waves 1.13 – Update SeatermW to describe new DateTime menu. Also, SBE 53 added to Configuration dialog box (previously just showed 26plus). • Add information on upload time – 3.5 hours for 32 MB in binary at 115,200 baud. • Add Recovery section with information about relieving internal pressure if you suspect instrument is flooded. • Correct description of FR, which measures conductivity frequency (previously said it also mentions pressure and pressure temperature).
004	05/06	<ul style="list-style-type: none"> • Remove low range pressure sensor and plastic housing options, and add high accuracy T sensor option (corresponding to changes in price list).
005	03/08	<ul style="list-style-type: none"> • Add information that can upgrade firmware through the serial port for future changes. • DC response includes coefficients that weren't listed (FRA4, FRA5, FRA6). • TS response includes date and time. • Corrected StartTime to SetStartTime. • Change battery cover plate 41124A to 41124B. • Update Triton website information. • Update I/O cable photo on Unpacking page. • Maintenance: Revise cable mating information to be consistent with application note 57.
006	08/08	<ul style="list-style-type: none"> • Firmware 1.1e -- Add ExternalTemperature= (Y enables external thermistor in place of internal thermistor), update status responses to add line describing thermistor configuration.
007	05/09	<ul style="list-style-type: none"> • Seasoft for Waves 1.18 -- <ul style="list-style-type: none"> - .ini file for calibration coefficients changed to .psa file; small changes in dialog boxes for Convert Hex as a result. - Location of SeasoftWaves.ini changed, for better compatibility with Vista. • Clarify that Sea-Bird does not provide barometric pressure (.bp) file, must be created by customer.
008	06/09	<ul style="list-style-type: none"> • Update Convert Hex dialog boxes for version 1.18a of Seasoft for Waves.
009	08/09	<ul style="list-style-type: none"> • Correct dimensional drawing (battery end cap end has padeye instead of flat bar).
010	12/09	<ul style="list-style-type: none"> • Seasoft for Waves 1.18b: Add -t command line option information for Convert Hex (outputs additional diagnostic information in .tid file) • Update SBE address. • Add CE mark.
011	09/11	<ul style="list-style-type: none"> • Seasoft for Waves version 2.0: <ul style="list-style-type: none"> Convert Hex dialog box change. SeatermW menu change – Connect and Configure are now submenus of Communications menu. • Update recommended minimum system requirements for installing software; add information about compatibility with Windows 7.

Continued on next page

continued from previous page

012	04/13	<ul style="list-style-type: none"> • Add Declaration of Conformity. • Update housing drawing to show corrected length. • Add cable and internal wiring drawings. • Remove ExternalTemperature= command (factory-set based on customer's order of internal or external temperature sensor, and should not be modified by customer).
013	02/15	<ul style="list-style-type: none"> • Clarify that accuracy specifications are \pm. • Update Declaration of Conformity. • Add caution regarding using spray can lubricants on MCBH connectors. • Add caution regarding using Parker Super O Lube, not Parker O Lube (which is petroleum based). • Remove <i>standard</i> and <i>optional</i> language related to SBE 53 features. • Add information on O-ring maintenance. • Update language on where to find updated software on website. • Switch to Sea-Bird Scientific cover.

Index

A

Anti-Foulant Devices · 88

B

Barometric pressure · 49
 Batteries · 15
 replacing · 60
 Battery and Memory Endurance · 21
 Battery endurance · 21
 Baud · 30
 Baud rate · 17

C

Cable length · 17
 Cables · 13
 Calibration · 65
 Calibration coefficients · 40
 Calibration coefficients · 65
 CE certification · 3
 Cleaning · 58, 59
 Command summary · 71
 Commands
 baud · 30
 calibration coefficients · 40
 conductivity · 30
 data upload · 37, 45
 date and time · 30
 descriptions · 28
 diagnostic · 38
 general setup · 30
 Initialize logging · 34
 logging · 35
 memory upload · 37, 45
 polled sampling · 37
 real-time data · 30
 Reset memory · 34
 send last sample · 37
 start and stop · 32, 35
 status · 29
 temperature · 30
 testing · 38
 tide setup · 32
 troubleshooting · 38
 upload · 37, 45
 Communication defaults · 25
 Conductivity · 30
 Conductivity sensor
 maintenance · 59
 Conductivity sensor calibration · 67
 Connector · 58
 Connectors · 12
 Convert Hex · 47
 Corrections
 Pressure sensor drift · 85
 Corrosion precautions · 58

D

Data format · 20, 80
 .cap · 80
 .hex · 81
 .ref · 85
 .tid · 84
 converted data · 84
 Quartz · 81
 reference frequency data · 85
 tide data · 84
 uploaded data · 81
 Data I/O · 17
 Data plotting · 52
 Data upload · 37, 45
 Date and time · 30
 Declaration of Conformity · 3
 Deployment · 43
 Depth to pressure conversion · 92
 Description · 8
 Diagnostic · 38
 Dimensions · 12

E

Electronics disassembly/reassembly · 86
 End cap · 58
 End cap connectors · 12
 Extensions · 20, 80
 External power · *See* Power, external

F

Features · 8
 File extensions · 20, 80
 File formats · 20, 80
 Format · 20, 80
 .cap · 80
 .hex · 81
 .ref · 85
 .tid · 84
 converted data · 84
 Quartz · 81
 queried data · 80
 real-time · 80
 reference frequency data · 85
 tide data · 84
 uploaded data · 81

G

General setup · 30
 Glossary · 70

I

Initialize logging · 34
 Installation · 18, 43

L

Limited liability statement · 2
 Logging · 35

M

Maintenance · 58
 Manual revision history · 95
 Measurement sequence · 73
 Memory · 10
 Memory endurance · 21
 Memory upload · 37, 45
 Merge barometric pressure · 49

O

O-ring
 maintenance · 59

P

Parity · 17
 Parker Super O-Lube · 70
 Parts
 replacement · 93
 Photos · 7
 Plot Data · 52
 Polled sampling · 37
 Power · 15
 external · 16
 Power consumption · 10
 Power endurance · 21
 Pressure sensor
 maintenance · 61
 Pressure sensor calibration · 65
 Pressure sensor drift corrections · 85
 Pressure to depth conversion · 92
 Programming for deployment · 24

Q

Quick start · 6

R

Real-time data · 30
 Real-time setup
 baud rate · 17
 cable length · 17
 Recovery · 44
 Reference frequency data · 85
 Replacement parts · 93
 Reset memory · 34
 Revision history · 95

S

Sample timing · 73
 continuously powered · 74
 not continuously powered · 77
 SBE 4M
 maintenance · 59
 Seasoft for Waves · 19
 Battery and Memory Endurance · 21
 Convert Hex · 47
 file extensions · 20, 80
 file formats · 20, 80
 installation · 18
 Merge Barometric Pressure · 49
 Plot Data · 52
 SeatermW · 24
 updates · 18
 SeatermW · 24
 Send last sample · 37
 Sensors · 10
 Sequence · 73
 Setting time · 30, 42
 Setting up SBE 53 · 24
 Software · 18
 Software use · 19
 Specifications · 10
 Start and stop logging · 32, 35
 Status · 29
 Storage · 58, 59
 Summary · 8
 Super O-Lube · 70
 Synchronizing time · 42

T

Temperature · 30
 Temperature sensor calibration · 66
 Testing · 38
 Testing SBE 53 · 24
 Tide data · 47, 84
 Tide data processing · 49
 Tide setup · 32
 Time · 30, 42
 Timing · 73
 Triton · 70
 Troubleshooting · 38
 Troubleshooting · 68

U

Unpacking · 7
 Updates · 18
 Upload · 37, 45

V

Versions · 95

W

Wiring · 13